



OPHTHALMIC / AUGENHEILKUNDE

WILLKOMMEN BEI VEHU
SIE KENNEN UNS (NOCH) NICHT?

Wir sind ihr kompetenter Partner für die Veterinär- und Humanmedizin.

Denn wir bieten das komplette Programm an chirurgischen Instrumenten direkt aus Tuttlingen - dem weltzentrum der Medizintechnik.

Neben dem Vertrieb konzentrieren wir uns auf unsere Produktionsstätte –MRitter&Sohn GmbH in der wir hochpräzise chirurgische Instrumente entwickeln und fertigen – selbstverständlich auch kundenspezifische Aufträge.

Sowohl die Produkte aus unserer eigenen Herstellung und die Komponenten von ausgewählten Lieferanten, obliegen konsequent unserer strengen Kontrolle, Prüfverfahren und langjähriger Erfahrung.

So wird die gleichbleibende hohe Qualität aus unserem Hause gesichert und bereitgestellt. Für die hohe Anforderung in der Medizin.

WELCOME TO VEHU.
YOU DON'T KNOW US YET.

We are your competent partner for veterinary and human medicine.

We offer the entire range of surgical Instruments. Our headquarter is located in Tuttlingen, the world center of medical technology.

In addition to sales, we concentrate on our production site- MRitter&Sohn GmbH-in which we develop and manufacture high-precision surgical instruments- Of course, also custom orders.

Both the products of our own production and the components of selected suppliers are consistently subject to our strict control, testing procedures and many years of experience.

This way the constant high quality from our company is secured and made available. For the high requirement in the medicin



VeHu-Medical ist seit 2000 erfolgreich im medizinischen Bereich tätig. Wir bieten das komplette Sortiment chirurgischer Instrumente an. VeHu-Medical wurde ursprünglich im Jahr 2000 gegründet und wechselte 2015 zu MRitter & Sohn, einem etablierten Hersteller von chirurgischen Instrumenten. Der mittlerweile über zwei Generationen von Michael Ritter und Kevin Ritter geführt wird. Michael Ritter, der seine über drei Jahrzehnte lange Erfahrung in der Herstellung von chirurgischen Instrumenten einbringt und nach höchsten Qualitätsstandards herstellt. Die allen nationalen und internationalen Normen und Vorschriften entsprechen. Auch im Vertrieb, steht unsere Philosophie und Marke für herausragende Qualität. Einen Kundenservice mit persönlicher Beratung und zuverlässigen Service gewährleistet.

Das Produkt und die Erwartungen unserer Kunden stehen im Mittelpunkt und Fokus aller unserer Aktivitäten, um die Erwartungen, Wünsche und Anforderungen unserer Kunden auf höchstem Qualitätsniveau zu erfüllen. Unsere Datenbank umfasst 15.000 Standardartikel. Obwohl unser Lagerbestand in den letzten zwei Jahren verdoppelt wurde, fügen wir unserer Standardbestandsmenge kontinuierlich weitere Artikel hinzu, um die kürzeste Lieferzeit für unsere Kunden sicherzustellen. Unser Logistiksystem wurde an den neusten Stand der Technik angepasst und verfügt über eine geschulte Mitarbeiterzahl von mehr als 10 Mitarbeitern im Vertrieb und in der eigenen Produktion, um die tägliche Einhaltung der Produktionsqualität und Lieferzeiten sicherzustellen.

All dies spiegelt sich in unserer Flexibilität und Verfügbarkeit für jeden Kundenwunsch in Verbindung mit einem hervorragenden Preis-Leistungs-Verhältnis wider. Um die Einhaltung aller verbindlichen internationalen Standards zu gewährleisten, sind wir selbstverständlich ein nach DIN ISO 13485: 2016 und US-amerikanischen FDA zertifiziertes Unternehmen

Since 2000, VeHu-Medical has been successfully active in the medical sector. We offer a complete range of surgical instruments. VeHu-Medical was originally founded in the year 2000 and changed ownership in 2015 to MRitter & Sohn, a well established manufacturer of surgical instruments with the professional expertise of Michael Ritter and Kevin Ritter meanwhile over 2 generations of manufacturing surgical instruments of the highest quality standards complying with all national and international standards and regulations. After almost 2 decades of professional experience in manufacturing of surgical instruments, as well as the sales and distribution, our philosophy and brands stands for outstanding quality, a customer service with personal approach and advise and of course reliable on-time delivery are our strengths and ensure customer comprehensive and reliable service.

The product along with our customers expectations are the center and focus of all activities in order to meet our clients expectations, wishes, demands and requirements on the highest quality levels. Our database includes 15.000 standard articles and despite our stock value has been doubled over the last two years, we continuously adding more articles to our standard stock quantity to ensure the shortest possible delivery time for our clients. Our store and logistic system has been adapted to the last state-of-the-art requirements, along with a professional trained staff size of more then 10 employees in sales and own production to ensure production quality and delivery time compliance on daily bases.

All of the above is reflected by our flexibility and availability for any customer demand in combination with an excellent price-performance ratio. In order to ensure the compliance with all mandatory international standards we are, of course, a certified DIN ISO 13485:2016 and US FDA registered company



Catalog Number Prefix	Product Group	Page Number
VH310	Speculums & Retractors	6 - 13
HV320	Knives, Spuds Blade Breakers, Punches & Handles	15 - 16
VH330	Lasik/Lasek/Dalk, Curettes, Spatulas, Choppers, Manipulators, Loops, Spoons, Hooks, Fixation Rings, Muscle Hooks, Corneal Markers & Calipers	18 - 46
VH340	Scissors	48 - 58
VH350	Forceps	60 -100
VH360	Needle Holders	102 - 106
VH370	Lacrimal Instruments, Cannulas, Quickswitch I/A System, Infusion Handles, Bimanual Hand Pieces, Rongeurs, Nasal Speculums, Elevators, Chisels, Mallets & Probes	108 - 117
VH380	Bipolar Forceps	118
VH390	Sterilization Cases & Trays, Diagnostic Instruments	119 - 121

VeHtu

SALES & PRODUCTION

VH310

- Speculums
- Retractors

VH320

- Knives
- Spuds
- Blade Breakers
- Punches
- Handles

Baraquer Wire Speculums

- VH310-5000 standard wire 0.8mm, 10mm blades, 4.5cm
- VH310-5009 heavy wire 1mm, 15mm blades, 4.5cm
- VH310-5010 standard wire 0.8mm, 15mm blades, 4.5cm

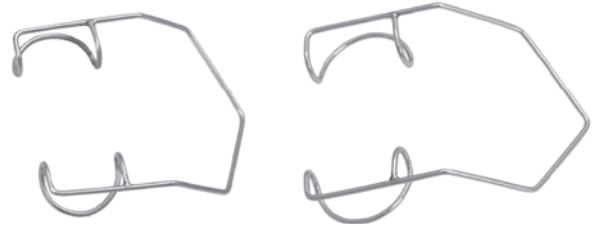

Baraquer Wire Speculums

Wire Speculum

- VH310-5355 10mm blades (infant), 3cm
- VH310-5356 15mm blades, 4.5cm

Grandon-Barraquer

- VH310-5011 15mm blades, 4.5cm

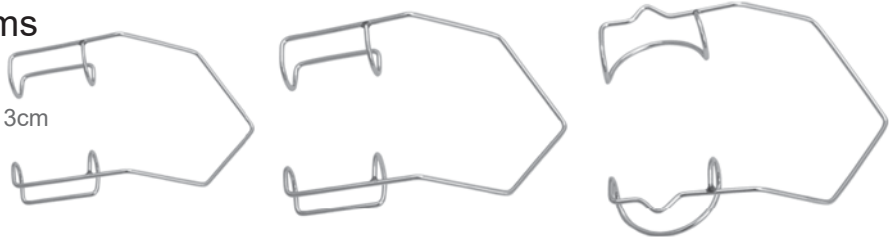

Temporal Approach

Wire Speculum
with spring on nasal side

- VH310-5012 15mm closed blades, 4.5cm
- VH310-5015 15mm open blades, 3.2cm



Kratz-Barraquer

Wire Speculum
with open blades
For unobstructed access to the
cataract incision with phaco or I/A tip.

- VH310-5049 heavy wire 1mm, 15 mm blades, 3.5cm
- VH310-5050 standard wire 0.8mm, 15mm blades, 3.5cm
- VH310-5051 standard wire 0.8mm, 13mm blades, 4.5cm
- VH310-18005/A standard wire 0.8mm, 15mm blades, 3.5cm
- VH310-18005/B heavy wire 1mm, 15 mm blades, 4.5cm

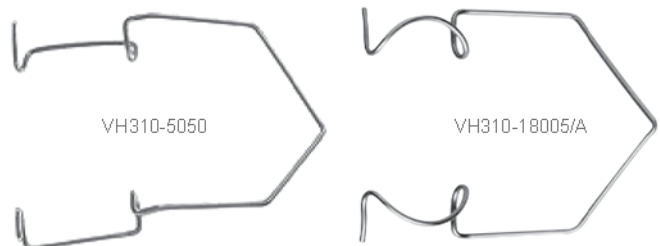

Barraquer Solid Blade

Wire Speculum

- VH310-5020 Barraquer, 10mm blades, 4.5cm
- VH310-5030 Barraquer, 15mm blades, 4.5cm
- VH310-5031 Feaster, 20mm blades, 4.5cm

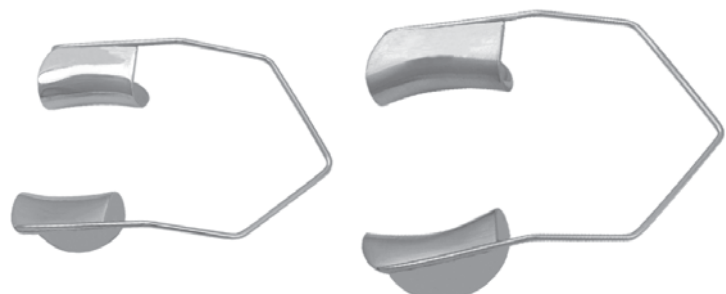

SPECULUMS

Sauer

Lid Speculum

VH310-5300 for infants, 11mm blades, 4.5cm

VH310-5302 for premature infants, 2mm blades, 4.5cm



Frankel

Infant Lid Speculum adjustable
for precise control of
infant eyelid retraction.

VH310-5310 10mm blades, 4.5cm

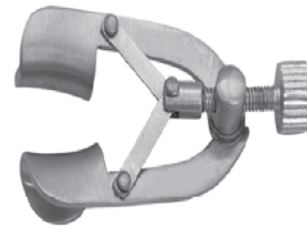

Infant Wire Speculum

VH310-5320 Blades size 5mm, Open, 3.5cm

VH310-5325 Blades size 5mm, Close, 3.5cm

VH310-5330 Blades size 6mm, Solid, 3.5cm

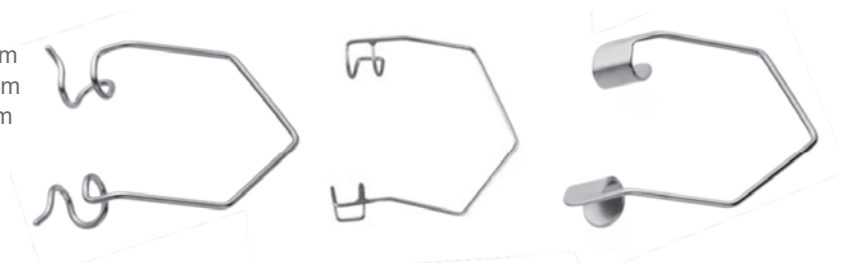

Alphonso

Infant Lid Speculum finger grips and
interlacing blades to facilitate insertion
one blade 5mm, one blade 7mm, 7cm

VH310-5340

Infant Lid Speculum

Lid Speculum closed wire blades
gently curved spring

VH310-5350 4mm blades, 3cm

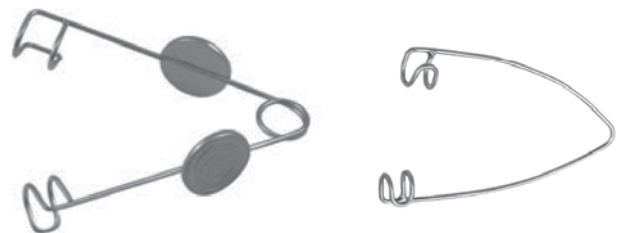

Cook Eye Speculum

Eye Speculum with locking screw

VH310-5401 #1, 8mm blades, 5.2cm

VH310-5402 #2, 11mm blades, 5.2cm

VH310-5403 #3, 15mm blades, 5.2cm



Murdoch

Eye Speculum with locking screw
VH310-5406 #2, 12mm blades, 5cm
VH310-5407 #3, 15mm blades, 5cm

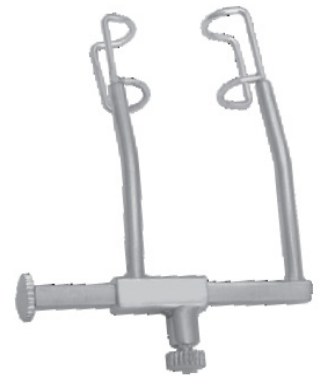

Mellinger

Eye Speculum self retaining
 for unobstructed access to the
 cataract incision with phaco or I/A tip.
VH310-5411 15mm blades, 7cm



Williams

Eye Speculum with locking screw
VH310-5500 11mm blades, 8cm
VH310-5510 15mm blades, 8cm



Knapp

Eye Speculum
VH310-5511 13mm blades, 8cm



Lancaster Speculum

Eye Speculum
 adjustable mechanism
 with locking nut
VH310-5600 16mm blades, 8cm



Lester - Burch Speculum

Eye Speculum with flanges on blades for retaining eye lashes
adjustable mechanism with locking screw, 8cm
VH310-5620



Lieberman Speculum

adjustable mechanism

- VH310-5665 Lieberman, K-wire, 5mm blades, infant, 8cm
- VH310-5670 Lieberman, K-wire, 10mm blades, small, 8cm
- VH310-5671 Lieberman, K-wire, 15mm blades, standard, 8cm
- VH310-5675 Lieberman, V-shaped, 15mm blades, 8cm
- VH310-5668 Tanna-Lieberman, 15mm blades, 8cm
- VH310-5673 Thorlakson, rounded, 13mm blades, 8cm
- VH310-5674 Lieberman, triple post, 13mm blades, 8cm
- VH3T10-5671 15mm K-wire,blades, 8cm **Titanium**
- VH3T10-5675 15mm W-wire,blades, 8cm **Titanium**
- VH3T10-5673 rounded, 13mm blades, 8cm **Titanium**

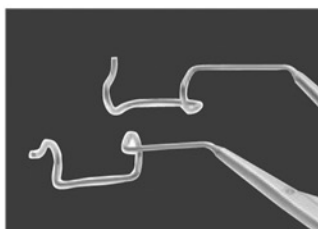

VH310-5670

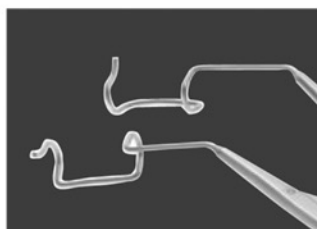

VH310-5671

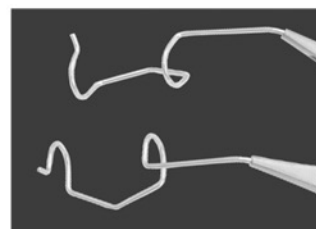

VH310-5675

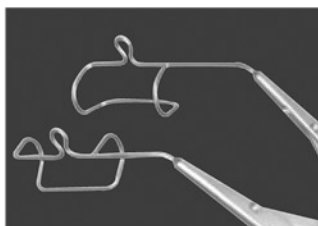

VH310-5668

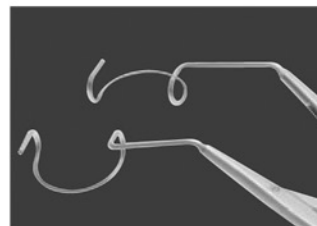

VH310-5673

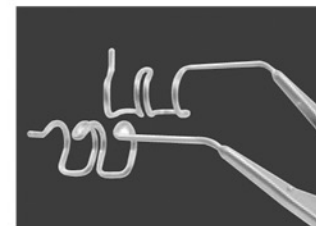

VH310-5674

Lieberman Speculum

Eye Speculum

Adjustable mechanism

non-reflective finish

VH310-5676 5mm blades, Infant, 8cm

VH310-5677 10mm blades, Small, 8cm

VH310-5678 15mm blades, Standard, 8cm



Jaffe

Wire Lid Retractor

VH310-8000 pair, 15mm blades (large), 3.5cm

VH310-8001 pair, 13mm blades (small), 4.5cm



Castroviejo Speculum

Eye Speculum

adjustable mechanism

VH310-5700 5mm blades, 12cm

VH310-5701 10mm blades, 12cm

VH310-5702 14mm blades, 12cm

VH310-5703 16mm blades, 12cm



Bangerter Speculum

VH310-1230 15mm blades, 12cm

VH310-1240 10mm blades, 12cm

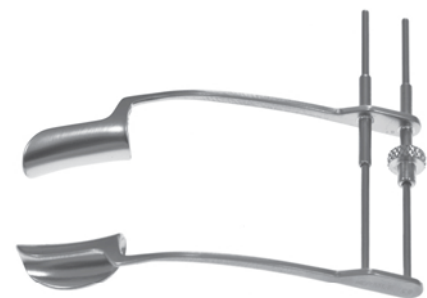

Lancaster Speculum

Lacrimal Sac Retractor

3x3 blunt prongs, adjustable, 12cm

VH310-9500



Stevenson

Lacrimal Sac Retractor

solid blades with serrated

edge adjustable

VH310-9520 13mm blades, 12cm



Weiss

EYE SPECULUM Fenestrated, 12cm
VH310-115950



Lieberman Style, aspirating

adjustable mechanism

Features aspirating ports to remove excess fluid from the surgical field. Supplied with silicone tubing and luer-lock adaptor.

- VH310-5171 Lieberman, Kratz style, 15mm blades, 8cm
- VH310-5173 Thorlakson, rounded, 11mm blades, 8cm
- VH310-5175 Lieberman, V-shaped, 15mm blades, 8cm
- VH310-5180 Chu, solid, reversible, 15mm blades, 8cm
- VH310-5179 Replacement silicone tubing, 100cm (39"), 8cm

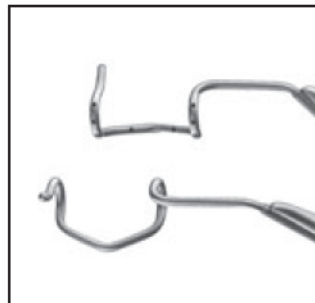
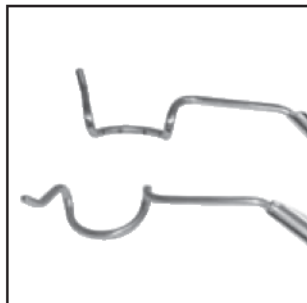

Flieringa

Scleral Fixation Ring

VH310-7100 set of eight, 15mm-22mm

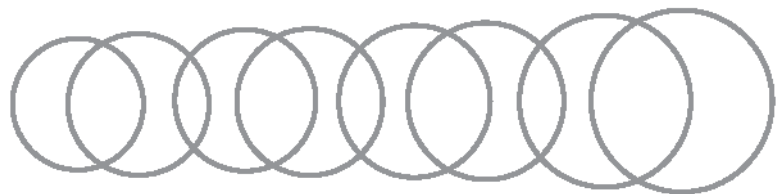

McNeill-Goldman

Scleral Fixation Ring and Blepharostat

- VH310-7311 Small, 15mm I.D.
- VH310-7312 Medium, 16mm I.D.
- VH310-7313 Large, 17mm I.D.



Schocket

Scleral Depressor double-end with pocket clip 6mm wide bar and 2.5mm tear drop, 13.5cm
VH310-7825



Josephberg-Besser

13.5cm
VH310-7822

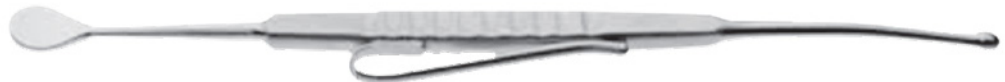

Schepens

Orbital Retractor, 13cm
VH310-7880



Senn

Senn Miller Lid Retractor
VH310-8100 Sharp, 7x8mm, 16 cm 6¼", 13cm
VH310-8120 Blunt, 7x8mm, 16 cm 6¼", 13cm



Senn

Senn Miller Lid Retractor, Double Ended
VH310-8150 Sharp, 13cm
VH310-8160 Blunt, 13cm



Desmarres

Lid Retractor thin solid blades
VH310-8200 size 0, 11mm wide, 13cm
VH310-8210 size 1, 13mm wide, 13cm
VH310-8220 size 2, 15mm wide, 13cm
VH310-8230 size 3, 17mm wide, 13cm



RETRACTORS

Jaeger

Lid Plate

VH310-8500 stainless steel, Small, 10cm

VH310-8510 stainless steel, Large, 11cm



Wright

Fascia Needle

1mm x 6mm oval hole

140mm long, 14cm

VH310-8540



Knapp

Lacrimal Retractor

4 prongs

VH310-9000 blunt, 13cm

VH310-9001 sharp, 13cm



Rollet

Rollet retractor

VH310-9002 4-blunt, 13cm

VH310-9003 3-blunt, 13cm



Helveston

Tissue Retractor

thin curved blade

VH310-9010 "Barbie" 7mm wide, 13cm

VH310-9012 "Big Barbie" 9mm wide, 13cm

VH310-9019 "Great Big Barbie" 11mm wide concave blade, 13cm



Tooke

Corneal Knife
straight blade
with curved cutting edge, 13cm
VH320-3650



Gill

Corneal Knife
curved cutting edge
VH320-3700 straight, 13cm
VH320-3710 light curve, 13cm



Fukasaku

"Hockey" Knife
sharp 3mm front edge
semi-sharp 6mm
bottom edge, 13cm
VH320-3735



Foreign body spuds

VH320-4000 Golf Club, angled, lightly rounded tip, 13cm
VH320-4050 Francis, angled, flag shaped tip, 13cm
VH320-4100 Ellis, lightly curved and rounded tip, 13cm



VH320-4000 VH320-4050 VH320-4100



Spud & Gouge

in reversible handle for
removing foreign bodies, 13cm
VH320-4600

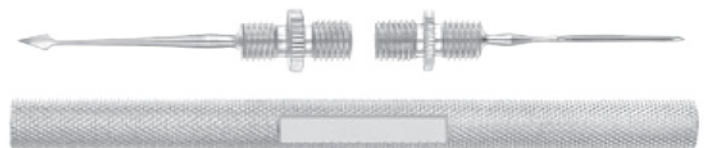

Gass

Corneoscleral Punch
1.5mm diameter head
0.75mm deep bite
rotatable tip for
convenient positioning, 15cm
VH320-9500

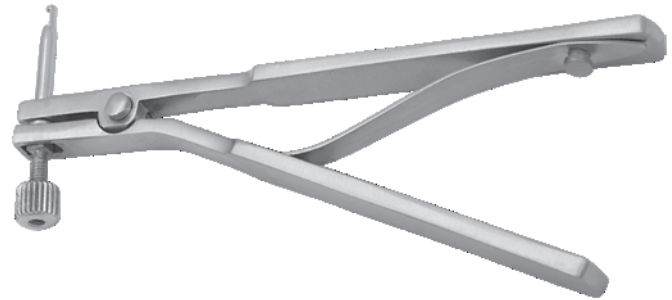
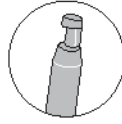

Kelly

Descemet's Membrane Punch
1.0mm diameter head
0.75mm deep bite, 15cm
VH320-9510

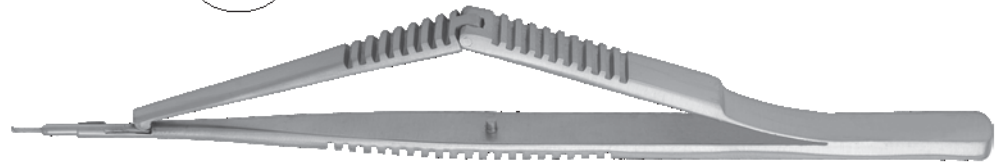
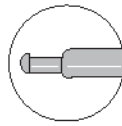

Fukasaku

Micro Trabeculectomy Punch
0.6mm diameter head
with bullet shaped tip
0.3mm x 0.6mm deep bite, 15cm
VH320-9512

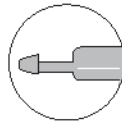

Christensen

Punctum Punch
1mm wide bite
for opening stenotic punctums, 15cm
VH320-9525

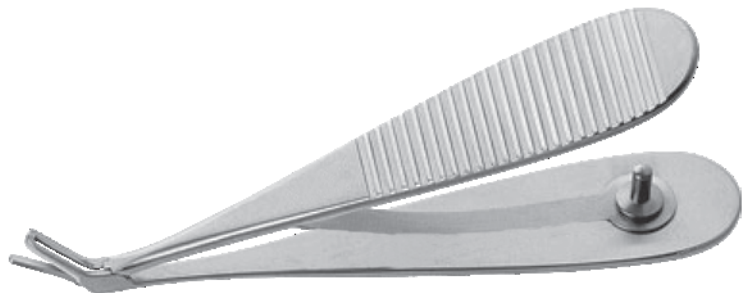

Castroviejo

Blade breaker and holder
with sliding lock, 15cm

VH320-5000



Swiss Model

Blade breaker and holder
spherical tip, 15cm

VH320-5150



Chuck Handle

round, serrated

VH320-1910 7.5cm

VH320-1920 10cm



Barron Handle # 3

VH320-1971 13cm



VH330

Curettes

Spatulas/Choppers/

Manipulators/Loops

Loops/Spoons/Manipulators

Hooks/Manipulators

Fixation Rings

Muscle Hooks

Corneal Markers

Calipers

Meyerhoefer

Chalazion Curette

VH330-1000 #0, 13cm * 1.5mm dia.

VH330-1010 #1, 13cm * 1.75mm dia.

VH330-1020 #2, 13cm * 2.25mm dia.

VH330-1030 #3, 13cm * 2.5mm dia.

VH330-1040 #4, 13cm * 3.5mm dia.

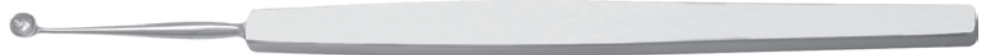
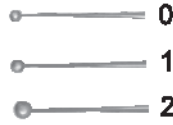

Double End Curette

VH330-1041 14cm size 1.5mm / 2.5mm dia.

VH330-1042 14cm size 2mm / 3mm dia.

VH330-1043 14cm size 2.5mm / 3.5mm dia.



Capsule

Polishing Curette

1.75mm diameter open ring

VH330-1100 Nightingale, semi-sharp, posterior edge, 13cm

VH330-1102 Shepherd, semi-sharp, anterior and posterior edges, 13cm

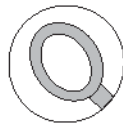

Culler

Iris Spatula

VH330-2100 1mm wide, 13cm

VH330-2110 2mm wide, 13cm

VH330-2111 nettleship iris reposer, 13cm



Wheeler

Double-End Spatula

lightly curved, 13cm

VH330-2120



Barraquer

Iris Spatula

round, smooth

VH330-2300 0.5mm diameter, 13cm

VH330-2310 0.25mm diameter, 13cm



Buratto

LASIK Flap Protector
For retracting and
protecting nasally hinged
corneal flaps, 13cm
VH330-1770



Buratto

LASIK Flap Protector
blades angled 15° For retracting
and protecting superiorly
hinged corneal flaps, 13cm
VH330-1772



Mannis - Buratto

LASIK Flap Protector
blades angled 45°
For retracting and protecting
superiorly hinged corneal flaps, 13cm
VH330-1773



Rowen

Combination LASIK Flap
Protector and Spatula, 14cm
VH330-1774



Dalk

Corneal Dissector
VH330-1870
12mm long, flattened,
vaulted spatula with
beveled tip, 13cm
VH330-1875
Rosenwasser DALK Trisector
with triangular shaft and
spatulated tip, 13cm

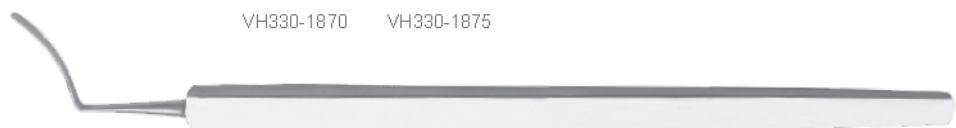
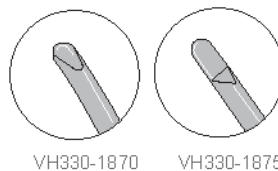

Endothelial Stripper

1mm wide, thin beveled tip

VH330-1830 smooth surface, 13cm

VH330-1835 sofenwasser with textured surface, 13cm

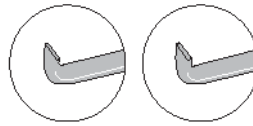

Sloane

LASEK Flap Repositor
gently curved spatulated tip
with beveled smooth edges
for repositing and smoothing
the epithelial flap after laser
ablation, 13cm

VH330-1845

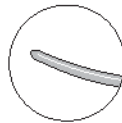

Camellin style

LASEK Trepphine &
alcohol retaining well

VHT320--7830 8mm trephine and 8.5mm well, 13cm



Camellin style

LASEK Alcohol Well
For retaining alcohol solution
on the corneal epithelium.

VH330-1820 8.5mm diameter, 13cm

VH330-1820T 8.5mm diameter, 13cm titanium

VH330-1822 9.5mm diameter, 13cm

VH330-1822T 9.5mm diameter, 13cm titanium



Anis

Capsule Scrubber flexible
wire textured disc, 12cm

VH330-1111

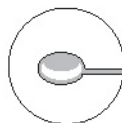

Moran

LASIK Enhancement
Spatula Fukasaku spatula
and a modified paton spatula, 12cm
VH330-2524



Corneal Dissector

for intrastromal dissection.
VH330-3660 angled, straight blade, 12cm
VH330-3661 angled, curved blade, 12cm

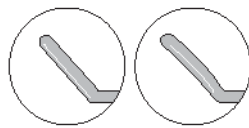

VH330-3660 VH330-3661

Fogla Pointed Dissector

Fogla Pointed Dissector, 12cm
VH330-4924

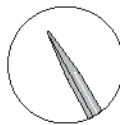

Carlson DSEK Smoother

Carlson DSEK Smoother, 12cm
VH330-2040



Fogla Trifacet Spatula

Fogla Trifacet Spatula, 12cm
VH330-0479



Hersh

Flap spatula beveled tips
a combination of a 6mm
spatula and 10mm spatula, 12cm
VHT330-2526

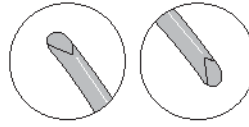

Binder

Flap elevator 1mm wide 12mm
semi-sharp edges, 12cm
VHT330-2528

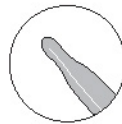

Fukasaku

LASIK Spatula rounded anterior
and flat posterior surface with
beveled tip for lifting and
dissecting the corneal flap, 12cm
VHT330-2530

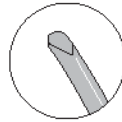

Guimaraes

LASIK spatula
gently curved, bi-convex
semi-sharp edges, 12cm
VHT330-2532

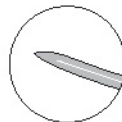

Katzen

LASIK Flap "Unzipper"
combines a modified
sinskey hook and a
bi-convex spatula, 12cm
VHT330-2534

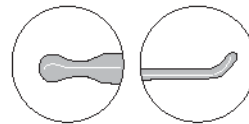

Maddox

LASIK Spatula
combines a flat spatula and
a cylindrical spatula for
elevating and repositing the flap, 12cm
VHT330-2535



Thorlakson

Flap Lifter combines a modified Sinskey hook and a bi-convex spatula with beveled notches.

VHT330-2536 long handle, 12cm

VHT330-2537 short handle, 12cm

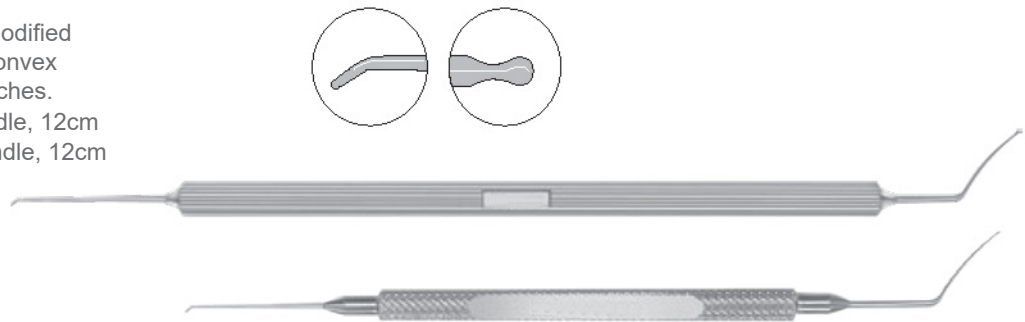

Lasik Flap Lifter

Combines a 45° angled sinskey hook and a thin hook with a tip

VHT330-2538 12cm

VH330-2538T 12cm titanium

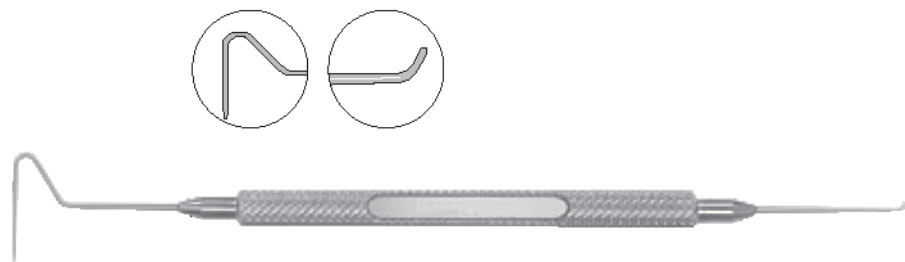

SPATULAS/CHOPPERS/MANIPULATORS

Hirschmann

Lens spatula flat
0.5mm wide with
multiple notches, 12cm

VHT330-2550



Jaffe

Lens spatula flat
0.5mm wide, 12cm

VHT330-2600



Lester

IOL Manipulator
0.25mm diameter tip ideal
for multi-directional manipulation
straight, with guard, 12cm

VHT330-2680

IOL Manipulator
0.25mm diameter tip
vaulted shank
with guard, 12cm

VHT330-2692

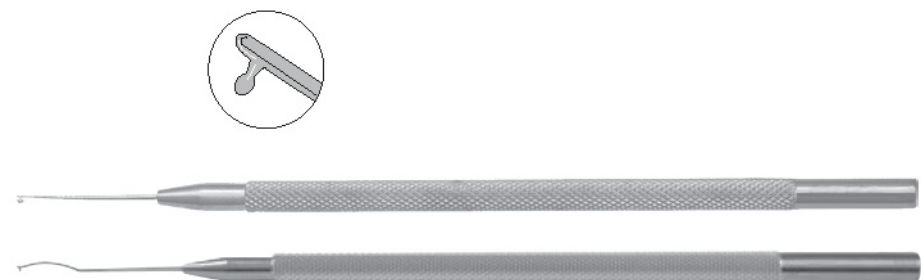

Phaco chopper

Chopper 10mm angle to tip
blunt cutting tip, 12cm

VH330-2180.8T titanium

Chopper 10mm angle to tip
rounded front, 90° cutting edge, 12cm

VH330-2180.25T titanium

Delicate 10mm angle to tip
short tip, 90° cutting edge, 12cm

VH330-2180.29T titanium



Mics Phaco Pre-chopper

For bimanual nucleus pre-chopping

VH330-2323 Alio-Rosen,

with two defined edges, 12cm

VH330-2324 Alio-Scimitar, curved

with blunt tip and sharp inferior edge, 12cm

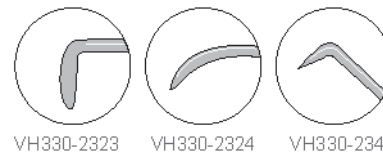

Milder

Phaco Chopper

60° offset inferior wedge

for horizontal chopping and a

beveled distal tip for vertical chopping

VH330-2343 for use in left hand, 12cm

VH330-2343T for use in left hand, 12cm titanium

Brierley

Nucleus Splitter

with incision sealing shaft

VH330-2380 12cm

VH330-2380T 12cm titanium



Dodick - Kammann

Nucleus Chopper

for bimanual nucleus division.

VH330-2382 1.5mm long tip, str, 12cm

VH330-2383 1.5mm long tip, angled, 12cm

VH330-2384 2mm long tip, straight, 12cm

VH330-2385 2mm long tip, angled, 12cm

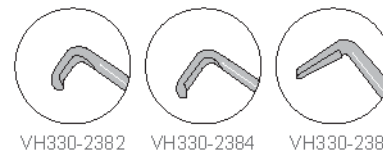

Escaf

Nucleus Divider

1.25mm long wedge shaped tip

for vertical chopping.

VH330-2387 12cm

VH330-2387T 12cm titanium



Claw Chopper

1.5mm claw shape, 12cm

VH330-1446

Green nucleus divider

cutting 45 degree to access, 65 degree angle shaft, tip to angle length 10mm, 12cm

VH330-1447

Ball tip 0.7mm inferior wedge

VH330-2327 12cm

Naghara Phaco Chopper

Rounded, blunt tip 0.9mm inferior wedge

VH330-2329, 12cm

VH330-2329T 12cm titanium

Phaco Chopper

rounded, blunt, olive-tip offset inferior wedge

VH330-2332 for use in right hand, 12cm

VH330-2333 for use in left hand, 12cm

Minardi Phaco Chopper

0.7mm long "Quick Chop" tip

VH330-2370 12cm

VH330-2370T 12cm titanium

Agarwal Karate Phaco Chopper

semi-sharp, wedge shaped inferior edge with a pointed tip.

VH330-2375 12cm

VH330-2375T 12cm titanium

Chang MicroFinger Chopper

curved finger shaped tip with defined inner edge for horizontal chopping

VH330-2377 12cm

Koch Nucleus Chopper

1.6mm long with blunted tip with rounded surfaces designed for safely splitting and dividing a very soft nucleus

VH330-2386 12cm

VH330-2386T 12cm titanium

Fukasaku wedge shaped inferior edge

VH330-2392 12cm Snapper Hook

VH330-2393 12cm Small pupil Snapper Hook

with notch to engage the iris

Rosen Phaco Splitter

wedge-shaped inferior edge blunt tip.

VH330-2395 12cm inline wedge, standard

VH330-2395T 12cm inline wedge, standard titanium

VH330-2396 12cm 60° offset wedge, for use in left hand.

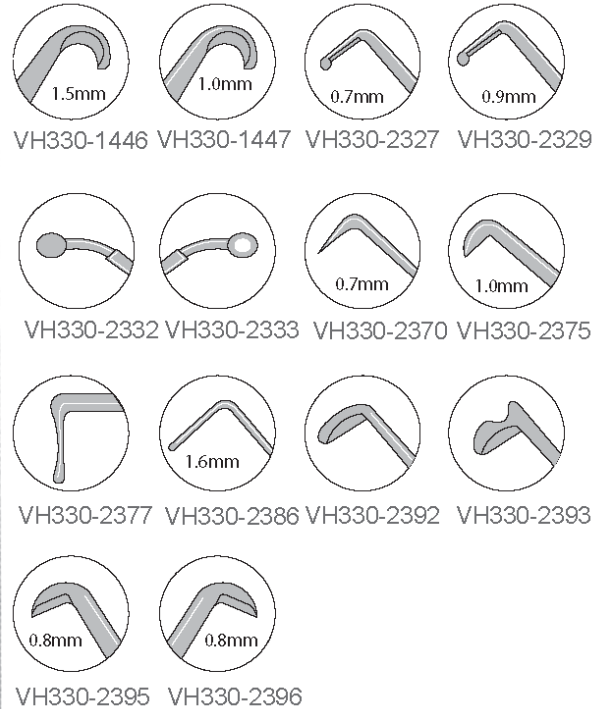

Nagahara

Nucleus Spatula flat inferior edge

VH330-2390 12cm

VH330-2390T 12cm titanium

VHM330-2390A 12cm french Pattern



VH330-2390

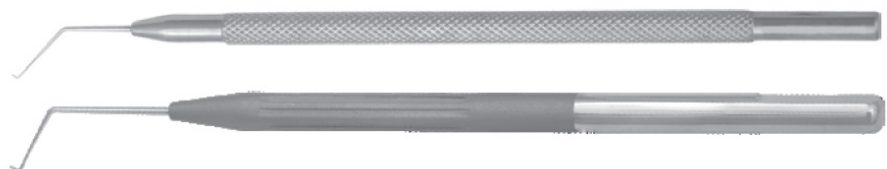

Gimbel

Nucleus Spatula
round, smooth
angled 30° at
10mm from the tip
0.25mm diameter, 12cm
VH330-2312

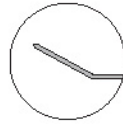

Knolle

Nucleus Spatula
malleable stainless steel,
flat 0.5mm wide, 12cm
VH330-2350

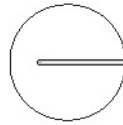

Koch

Nucleus Spatula
gently curved duckbill
shaped tip
VH330-2354 smooth, 12cm
VH330-2355 with notches, 12cm

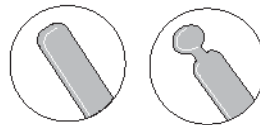

Escaf

Nucleus Manipulator
flattened olive-shaped tip angled at 45°
VH330-2347 12cm
VH330-2347T 12cm titanium



VH330-2347

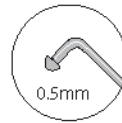

VH330-2357

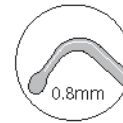

VH330-2359

Akahoshi

0.5mm diameter bulbous tip,
tip length 1.5mm 45° angled
shaft, tip to angle length 10.0mm
VH330-2357 12cm
VH330-2357T 12cm titanium

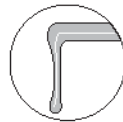

VH330-2360

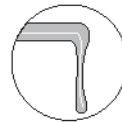

VH330-2361

Escaf

Nucleus Sustainer
smooth ball tip textured inferior surface, 12cm
VH330-2359



Lieberman

MicroFinger Nucleus Manipulator
VH330-2360 for use in right hand, 12cm
VH330-2361 for use in left hand, 12cm

Neuhann

Nucleus Divider
strongly curved spatulated tip, 12cm
VH330-2388



Tennant

Nucleus Rotator
with 0.6mm diameter
ball shaped tip
VH330-2428, 12cm
VH330-2428T 12cm titanium



Hunkeler

IOL Manipulator
with 0.3mm diameter
hemi-ball tip,
vaulted shank, 12cm
VH330-2695

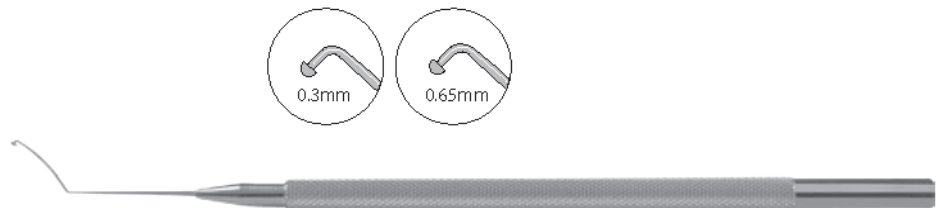

Mushroom

IOL manipulator angled
with 0.65mm diameter ball tip
VH330-2696 12cm
VH330-2696T 12cm titanium



Nucleus sustainer

Nucleus splitter and sustainer,
curved, blunt tip to be used
with the prechoppers, 12cm
VH330-2192.01T titanium



Scoring" reverse hook

"Scoring" reverse hook for DSEK,
sharp, angled, 12cm
VH330-2183.10T titanium
DSEK stripper,
"T" shaped tips, 12cm
VH330-2183.12T titanium

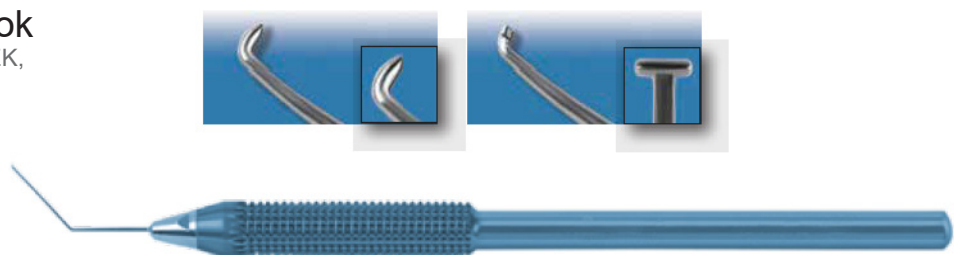

Masket

a combination of the Rosen Phaco Splitter and a 12mm long round Phaco Spatula with disc shaped tip

VH330-2367 12cm

VH330-2367T 12cm titanium

Chang

Phaco Chopper a combination of a modified MicroFinger and a 0.9mm long "Quick Chop" tip.

VH330-2368 for use in right hand, 12cm

VH330-2368T titanium for use in right hand, 12cm

VH330-2369 for use in left hand, 12cm

VH330-2369T titanium for use in left hand, 12cm

Milder

Phaco Chopper, double-end 60° for a beveled distal tip for vertical chopping and 12mm long spatula disc-shaped tip

VH330-2344 for use in right hand, 12cm

VH330-2345 for use in left hand, 12cm

Hwang

Phaco Chopper 1mm long vertical chopper and a chisel tipped spatula

VH330-2374 12cm

VH330-2374T 12cm titanium

Warren

Combination of a 3.5mm long MicroFinger and 2mm long pointed "Quick Chop" tip for veterinary use only.

VH330-2379 12cm

Rowen

Phaco Spatula a combination of the Rosen Phaco Splitter and the Bechert Nucleus Rotator

VH330-2398 12cm

VH330-2398T 12cm titanium

Chang - Seibel

Phaco Chopper, a combination chopper with the Chang MicroFinger end and Seibel Vertical Chopper

VH330-2340 for use in right hand, 12cm

VH330-2340T titanium for use in right hand, 12cm

VH330-2341 for use in left hand, 12cm

VH330-2341T titanium for use in left hand, 12cm

Sharp Chopper & Blunt Chopper

A combination sharp chopper & blunt chopper

VH330-2705 12cm

VH330-2705T 12cm titanium

Mushroom & Chopper

A combination of the mushroom and nagahara chopper

VH330-2698 12cm

VH330-2698T 12cm titanium

Mushroom & Y Pusher

A combination of mushroom and Y pusher bechert

VH330-2699 12cm

VH330-2699T 12cm titanium

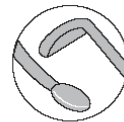

VH330-2367

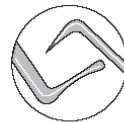

VH330-2368

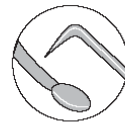

VH330-2344



VH330-2374



VH330-2379



VH330-2398

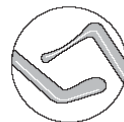

VH330-2340

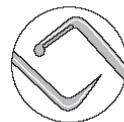

VH330-2705



VH330-2698



VH330-2699

Double Ended

Combination of 0.65mm mushroom tip and Nucleus Splitter

VH330-085 12cm

VH330-085T 12cm **titanium**

Combination of nagahara blunt chopper and sinskey hook

VH330-086 12cm

VH330-086T 12cm **titanium**

Combination of 0.65mm mushroom and sinskey hook

VH330-087 12cm

VH330-087T 12cm **titanium**

Combination of nagahara blunt chopper and spatula

VH330-088 12cm

VH330-088T 12cm **titanium**

Combination of sinskey hook and spatula

VH330-089 12cm

VH330-089T 12cm **titanium**

Combination of 0.65mm mushroom tip and spatula

VH330-090 12cm

VH330-090T 12cm **titanium**

Combination of 0.65mm mushroom tip and Y bechurt

VH330-091 12cm

VH330-091T 12cm **titanium**

Combination of sinskey hook and Y bechurt

VH330-092 12cm

VH330-092T 12cm **titanium**

Combination of nagahara blunt chopper and Y bechurt

VH330-093 12cm

VH330-093T 12cm **titanium**

Combination of 0.65mm mushroom tip and sharp chopper

VH330-094 12cm

VH330-094T 12cm **titanium**

Combination of sinskey hook and sharp chopper

VH330-095 12cm

VH330-095T 12cm **titanium**

Combination of nagahara blunt chopper and sharp chopper

VH330-096 12cm

VH330-096T 12cm **titanium**

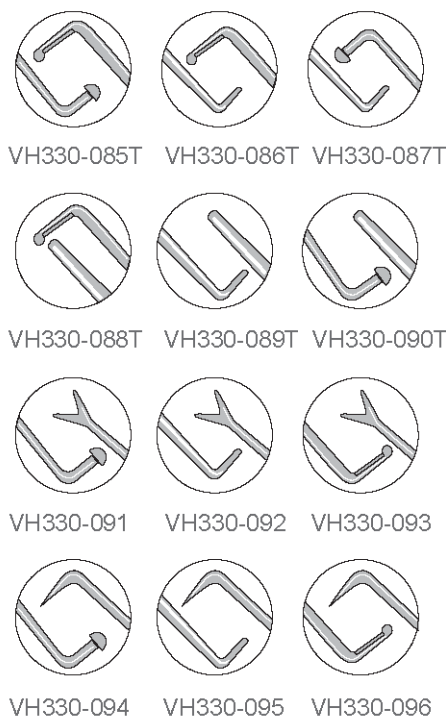
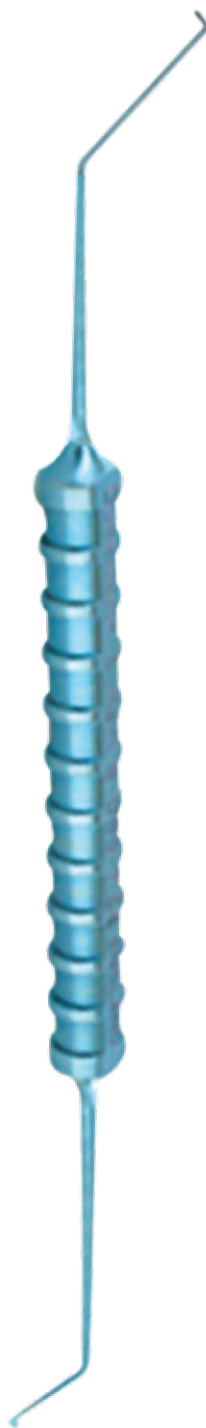

Bechert

Nucleus Rotator blunt forked tip
VH330-2400 angled at 7mm, 12cm
VH330-2400T angled at 7mm, 12cm **titanium**
VH330-2410 angled at 9mm, 12cm
VH330-2410T angled at 9mm, 12cm **titanium**

Bechert

Lens Pusher vertical Y-shaped tip angled.
VH330-2727 12cm
VH330-2727T 12cm **titanium**

Drysdale

Nucleus Manipulator paddle shaped tip
VH330-2418 rounded edges, 12cm
VH330-2418T rounded edges, 12cm **titanium**
VH330-2419 defined anterior edge for capsule polishing, 12cm

Pisacano

Nucleus Rotator flat disc shaped tip
VH330-2420 horizontal, 12cm
VH330-2420T horizontal, 12cm **titanium**
VH330-2421 vertical, 12cm
VH330-2421T vertical, 12cm **titanium**

Siepsier

Endocapsular Controller trumpet shaped tip
VH330-2425 12cm

Anis

Nucleus Manipulator with 0.5mm diameter ball tip
VH330-2426 straight, 12cm
VH330-2427 angled, 12cm

Grayson

Nucleus Manipulator flattened, smoothly polished 1.1mm long with "tear-drop" shaped tip, 12cm
VH330-2417

Lester

IOL Manipulator 0.25mm diameter tip Ideal for multi-directional manipulation.
VH330-2690 12cm
VH330-2690T 12cm **titanium**
 IOL Manipulator 0.25mm diameter tip vaulted shank For engaging the inferior haptic without touching the dome of the IOL.
VH330-2691 12cm
VH330-2691T 12cm **titanium**

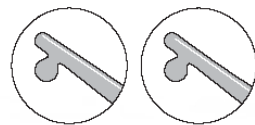
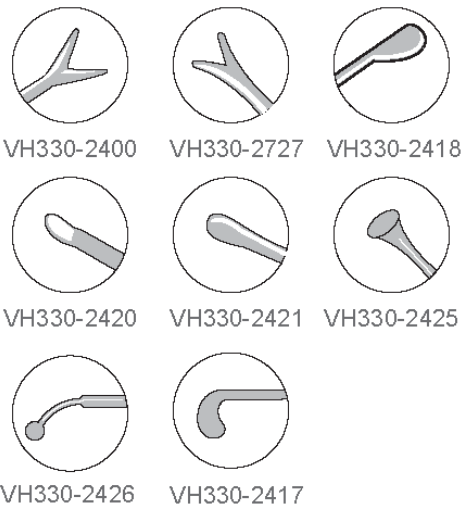

Reversed Sinskey Hook

0.2mm diameter blunt tip for scoring the recipient endothelium and positioning the donor lamella, 12cm

VH330-5002

Sinskey

Lens Manipulating Hook round handle
0.25mm diameter blunt tip

VH330-5192 straight, with guard, 12cm

VH330-5193 angled, 12cm

VH330-5193T angled, 12cm titanium

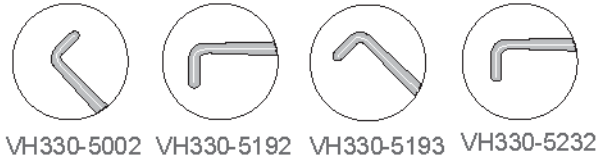

VH330-5002 VH330-5192 VH330-5193 VH330-5232

Sinskey II

Lens Manipulating Hook
0.2mm diameter blunt tip round handle

VH330-5232 straight, with guard, 12cm

VH330-5233 angled, 12cm

VH330-5233T angled, 12cm titanium



VH330-5232 VH330-5250 VH330-5400

Lewicky

Lens Manipulating Hook
0.15mm dia blunt tip ang vaulted shank

VH330-5250 12cm

VH330-5250T 12cm titanium

Hirschman

Iris Hook blunt, angled, 12cm

VH330-5400



Bonn

Micro Iris Hook blunt, flat handle, 12cm

VH330-5060

Shepard

Iris Hook blunt, 12cm

VH330-5110

Lens Manipulating Hook

0.15mm diameter blunt tip

VH330-5160 Jaffe, straight, 12cm

VH330-5170 Clayman-Jaffe, angled, 12cm

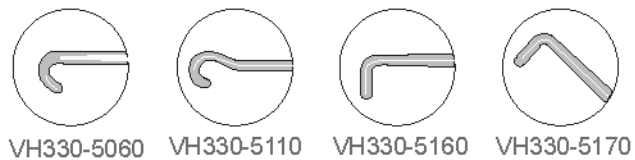

VH330-5060 VH330-5110 VH330-5160 VH330-5170

Sinskey

Lens Manipulating Hook
0.25mm diameter blunt tip straight, 12cm

VH330-5180

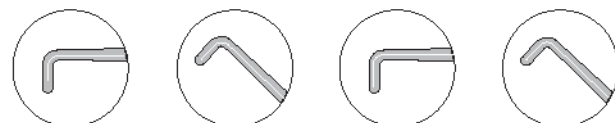

VH330-5180 VH330-5190 VH330-5220 VH330-5230

Harris - Sinskey

Lens Manipulating Hook, 12cm
0.25mm diameter blunt tip angled

VH330-5190



Sinskey II

Lens Manipulating Hook
0.2mm diameter blunt tip

VH330-5220 straight, 12cm

VH330-5230 angled, 12cm

Lippman

Nucleus Spatula
0.5mm diameter round
shaft with blunt forked tip, 12cm
VH330-2430



Girard

Synechiaie Spatula
0.5mm wide with
semi-sharp tip, 12cm
VH330-2500



Obstbaum

Synechiaie Spatula
0.25mm wide with
semi-sharp tip, 12cm
VH330-2520



Benedetto

Spatula 10mm long,
smoothly polished
flattened spatula
with beveled notches, 12cm
VH330-2522



Elsching

Cyclodialysis Spatula
flat, 1mm wide, 12cm
VH330-3000



Castroviejo

Synechiaie Spatula
0.5mm wide with
semi-sharp tips, 12cm

VH330-3150

Castroviejo

Cyclodialysis Spatula

VH330-3200 0.25mm wide, 12cm

VH330-3210 0.5mm wide, 12cm



Kimura

Platinum Spatula, 12cm

VH330-3500



Nucleus Dividing and Separating

VH330-52001 size: 0.6×1.2mm tip oval, 12cm

VH330-52003 size: 0.4×0.65mm tip oval, 12cm

VH330-52004 size: 0.4×0.65mm tip oval, 12cm



Straight Ring Manipulator

Straight shaft

0.5mm inside diameter, 0.8mm outside diameter, rounded tip

Round handle, length 121mm, 12cm

VH330-6462

0.5mm inside diameter, 0.8mm outside diameter, rounded tip

Angled shaft, tip to angle length 10mm

Round handle, length 118mm, 12cm

VH330-6462-1



0.8mm diameter, rounded tip

Angled shaft, tip to angle length 10mm

Round handle, length 118mm, 12cm

VH330-6462-2



Keener

Lens Divider
with three preformed snare
wire loops

VH330-3900 complete, 12cm
VH330-3910 wire loops, 12cm



Lens Loop

VH330-4000 Lewis, small, 12cm
VH330-4010 Lewis, Large, 12cm
VH330-4030 New Orleans, 12cm
VH330-4100 Wilder, serrated, 12cm



Kirby

Lens Loop and
Muscle Hook, 12cm
VH330-4105



Morrison

Lens Loop and
Probe, 12cm
VH330-4120



Lens Loop

serrated, 3mm wide
VH330-4140 Kansas, light curve, 12cm
VH330-4141 Keener-Arlt, strong curve, 12cm



Alfonso

Cutting Platform
Used as a cutting
block for nucleus
trisector.

VH330-4156 2mm wide, 12cm
VH330-4157 3mm wide, 12cm



Giannetti

Nucleus Capture Spoon, 12cm
VH330-4160

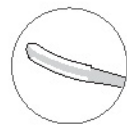

Culler

Lens Spoon
sterling silver, 12cm
VH330-4200



Paton

Spatula & Spoon
For corneal
button transfer, 12cm
VH330-4255



Bunge

Evisceration Spoon
VH330-4400 small, 12cm
VH330-4410 large, 12cm



Wells

Enucleation
Spoon, 12cm
VH330-4450



Graether

Collar Button
micro iris retractor
VH330-4900 straight, with guard, 12cm
VH330-4910 angled, 12cm



Keuch

Small Pupil Dilator
with guard for enlarging
a small pupil through the
sideport and primary incision, 12cm
VH330-4950

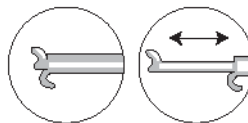

ICL Manipulator

VH330-5011 12cm

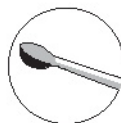

Bonn

Micro Iris Hook
extra delicate blunt,
round handle with guard, 12cm
VH330-5050



Kuglen Iris & Hook Lens Manipulator

- VH330-5500 Push-pull model, flat handle, straight, 12cm
- VH330-5520 Push-pull model, flat handle, angled, 12cm
- VH330-5510 Clover leaf model, flat handle, straight, 12cm
- VH330-5522 Push-pull model, round handle, straight w/guard, 12cm
- VH330-5523 Push-pull model, round handle, angled, 12cm

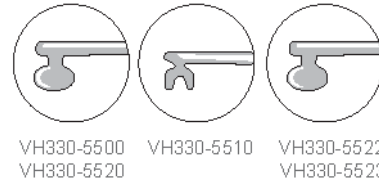

VH330-5500 VH330-5510 VH330-5522
VH330-5520 VH330-5523



Lens Manipulator

- straight, with guard
- VH330-5526 Rentsch, "Boat Hook", 12cm
- VH330-5528 Osher, Y-hook, 12cm

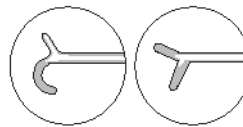

VH330-5526 VH330-5528



Lens Manipulating Hook

- 0.15mm diameter tip
- VH330-5530 Fenzl, round handle straight with guard, 12cm
- VH330-5531 Fenzl, round handle, angled, 12cm
- VH330-5532 Maltzman-Fenzl, round handle, straight with guard, 12cm
- VH330-5533 Maltzman-Fenzl, round handle, angled, 12cm
- VH330-5535 Jaffe-Maltzman, flat handle, angled, 12cm



VH330-5530 VH330-5532 VH330-5535
VH330-5531 VH330-5533

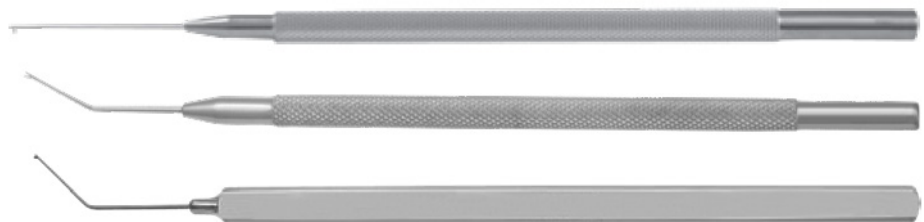

Deltz

- Lens Manipulating Hook
- 0.15mm diameter tip, 12cm
- VH330-5566

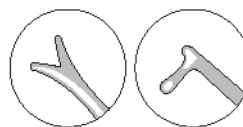

VH330-5566 VH330-2697

Alio - Kelman

- IOL Hook 0.2mm diameter tip, 12cm
- VH330-2697



Fixation Hook

double, sharp
VH330-6000 13cm
VH330-6010 13cm



Twist Hook

for scleral fixation
VH330-6100 right, 13cm
VH330-6110 left, 13cm

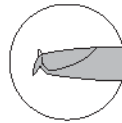

Silverman

Fixation Pick
blunt cone shaped tips
spaced 3mm apart
for atraumatic scleral fixatic
VH330-6130

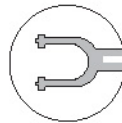

Globe Ring

Globe Fixation Ring
with concentric grooves
VH330-6153 for refractive procedures, 13cm
VH330-6154 for cataract procedures, 13cm

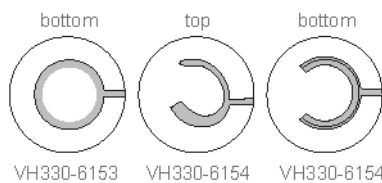

Lu - Mendez

LRI Guide and Fixation Ring
with delicate blunt teeth marks 10°
increments 11mm I.D.
VH330-6158 13cm
VH330-6158T 13cm titanium



FIXATION RINGS

Gimbel

Stabilization Ring
with swivel handle
13mm diameter with blunt teeth
on both sides
For stabilizing either the right or
left eye during LASIK, 13cm
VH330-6160



Fine - Thornton

Swivel Fixation Ring
blunt teeth features marks on anterior
surface in 15° increments as a guide
for placement of limbal relaxing incisions.

VH330-6161 13cm 13mm diameter

VH330-6161T 13cm titanium 13mm diameter



VH330-6163 13cm 16mm diameter



Thornton

Globe Fixation Ring multiple blunt teeth
16mm diameter ring

VH330-6165 13cm

VH330-6165T 13cm titanium



Hofmann - Thornton

Globe Fixation Ring
with swivel handle
16mm diameter ring
multiple blunt teeth, 13cm

VH330-6168



Stevens

Tenotomy Hook
blunt, small, 13cm
VH330-6600



Helveston

"Teaser" Hook
extra delicate, blunt, 13cm
VH330-6610



Graefe

Muscle Hook
VH330-6710 #1, 13cm
VH330-6720 #2, 13cm
VH330-6730 #3, 13cm

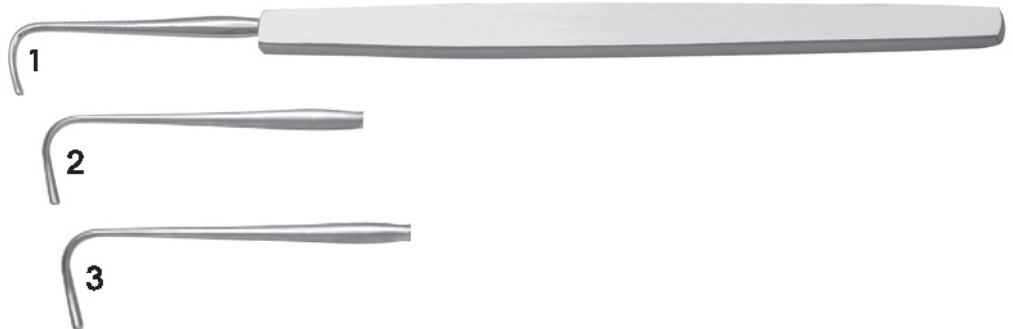

Gass

Retinal Detachment
Hook with oval hole, 13cm
VH330-6740



Helveston

Muscle Hook
extra delicate,
with blunt spatulated tip
VH330-6760 large, 13cm
VH330-6761 small, 13cm



MUSCLE HOOKS

Helveston

Muscle Hook
extra delicate, with blunt
spatulated tip
VH330-6778 8mm, 13cm
VH330-6780 10mm, 13cm
VH330-6782 12mm, 13cm



Jameson

Muscle Hook
VH330-6800 small, 13cm
VH330-6810 large, 13cm

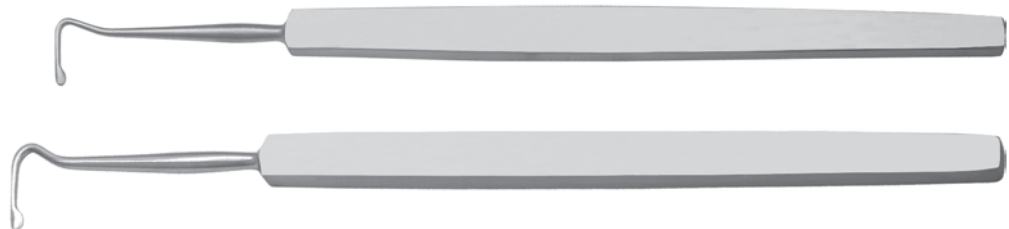

Du Plessis

Muscle Hook
double arm, 13cm
VH330-6814



Guyton

Small Incision
Muscle Hook, 13cm
VH330-6820



Green

Muscle Hook, 13cm
VH330-6850



Moorfields

Strabismus Hook, 13cm
VH330-6851



Mendez

Degree Gauge 12mm I.D.
marked in 10° increments
for accurate axial
alignment on the cornea

VH330-7900T 13cm titanium

VH330-7900 13cm

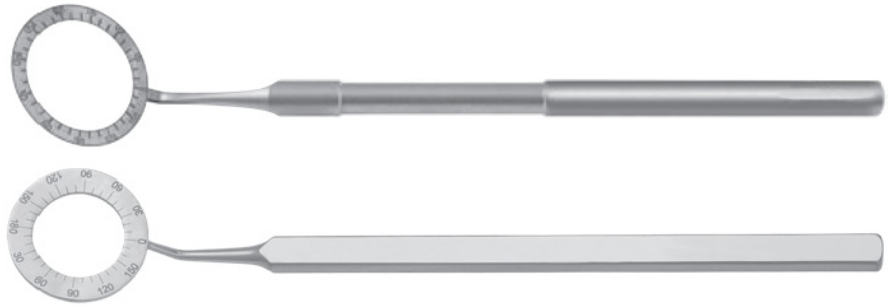

Bores

Axis Marker

VH330-7910T 13cm titanium

VH330-7910 13cm



Henderson

Degree Gauge 11.7mm I.D.
Beveled face with markings
in 5° increments 4 notches
on internal edge to align
with cardinal positions

VH330-7904T 13cm titanium

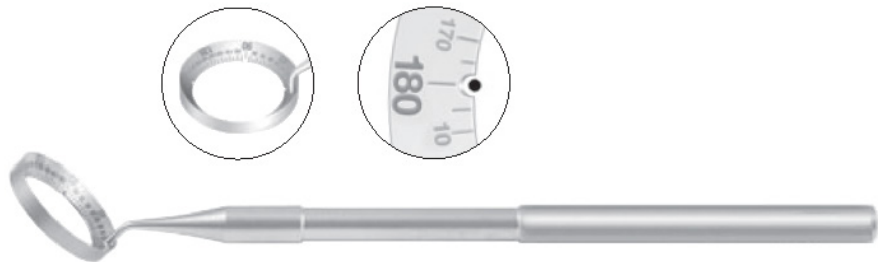

Henderson

Toric IOL Marker
two 2.5mm radial
marks extending to 11mm
(used with ST30-7904)

VH330-7912T 13cm titanium

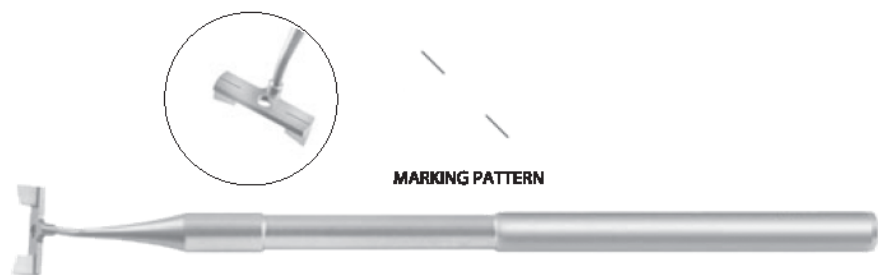

Henderson

Henderson Alignment Marker
with atraumatic disc-shaped
marking surfaces
at 3, 6 & 9 o'clock

VH330-7908T 13cm titanium

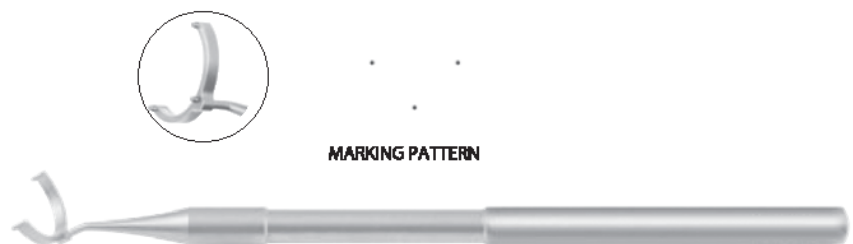

CORNEAL MARKERS

Optic Zone Markers

Bores, 12cm

VH330-8130 3.0mm	VH330-8137 4.75mm
VH330-8131 3.25mm	VH330-8138 5.0mm
VH330-8132 3.5mm	VH330-8142 6.0mm
VH330-8133 3.75mm	VH330-8146 7.0mm
VH330-8134 4.0mm	VH330-8150 8.0mm
VH330-8135 4.25mm	VH330-8154 9.0mm
VH330-8136 4.5mm	



Hoffer, with crosshairs, 12cm

VH330-8330 3.0mm	VH330-8410 5.0mm
VH330-8340 3.25mm	VH330-8412 5.5mm
VH330-8360 3.75mm	VH330-8414 6.0mm
VH330-8370 4.0mm	VH330-8418 7.0mm
VH330-8380 4.25mm	VH330-8422 8.0mm
VH330-8390 4.5mm	VH330-8426 9.0mm
VH330-8400 4.75mm	



Anis

Radial Marker

4mm diameter center opening
12.5mm O.D.

VH330-8852 8 blades, 12cm
VH330-8854 12 blades, 12cm
VH330-8855 16 blades, 12cm



Anis

Suture Placement Marker

8 radial blades
8mm diameter center opening
for corneal grafts, 12cm

VH330-8862



Fechtner

Trabeculectomy Marker, 12cm

VH330-8975



MARKING PATTERN



Mcdonald

Optic Zone Marker
double end, with cross hairs
VH330-8117
6.5 and 7.0mm diameters, 12cm



Osher Neumann

Osher-Neumann
Corneal Marker
VH330-8000 4 Line, 12cm
VH330-8001 8 Line, 12cm
VH330-8002 12 Line, 12cm



PRK Scraper

combination of
PRK Scraper and Marker
6.5mm marker
total length 112mm, 12cm
VH330-8003



Double Ended Marker

5mm diameter on one side
5.5mm opposite, 12cm
VH330-8004



Maloney

Intra-Operative
Keratometer titanium
for qualitative measurement
of astigmatism, 4cm
VH330-7888T titanium
VH330-7888



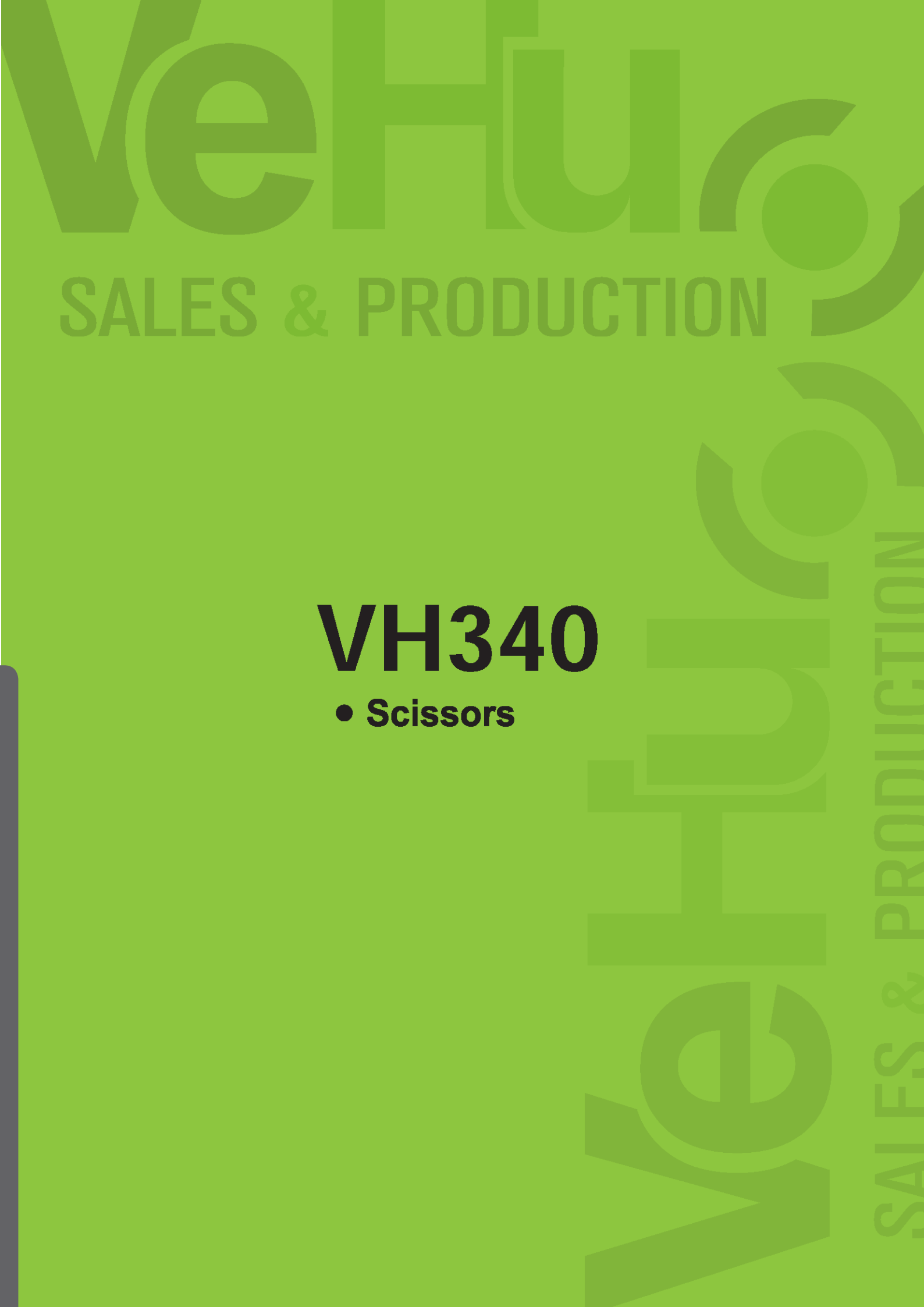

SALES & PRODUCTION

VH340

- **Scissors**

Vitreotomy Scissors

“Squeeze Handle” Scissors
these “squeeze handle”

instruments feature titanium
handles to reduce overall weight, and
front ends of hardened stainless steel
for secure cutting

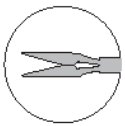

Scissors

horizontal, straight, 15cm
VH340-5300 20G 0.8 S.S
VH340-5300T 20G 0.8 titanium
VH340-5301 23G 0.6 S.S
VH340-5301T 23G 0.6 titanium

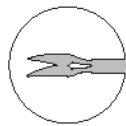

Scissors

horizontal, curved, 15cm
VH340-5310 20G 0.8 S.S
VH340-5310T 20G 0.8 titanium
VH340-5423 23G 0.6 S.S
VH340-5423T 23G 0.6 titanium
VH340-5425 25G 0.50 S.S
VH340-5425T 25G 0.50 titanium

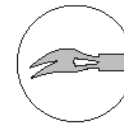

Scissors

horizontal, angled 45°, 15cm
VH340-5320 20G 0.8 S.S
VH340-5320T 20G 0.8 titanium
VH340-5321 23G 0.6 S.S
VH340-5321T 23G 0.6 titanium



Scissors

vertical opening straight, 15cm
VH340-5200 20G 0.8 S.S
VH340-5200T 20G 0.8 titanium
VH340-5201 23G 0.6 S.S
VH340-5201T 23G 0.6 titanium



Scissors

vertical opening angled 60°, 15cm
VH340-5240 20G 0.8 S.S
VH340-5240T 20G 0.8 titanium



Scissors

vertical opening angled 80°, 15cm
VH340-5250 20G 0.8 S.S
VH340-5250T 20G 0.8 titanium

ALIO

MICS scissors
23 gauge curved shaft with horizontal
micro blades for cutting delicate membranes, 15cm
VH340-5351T titanium



Horizontal blade

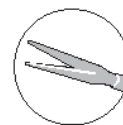

Vertical blade

YAE

Multi - Purpose 23G
vertical blade, 15cm
VH340-5352T 3mm blade 24mm long shaft 112mm titanium
VH340-5353T 2.5mm blade, 15mm long curved shaft 100mm titanium



Castroviejo

Corneoscleral Scissors
small blades, 11.5cm
VH340-1000 right
VH340-1010 left



Castroviejo

Corneoscleral Scissors
medium blades, 11.5cm
VH340-1020 right
VH340-1030 left



Troutman - Castroviejo

Corneoscleral Scissors
with stop, small blades, 11.5cm
VH340-1200 right
VH340-1210 left



Troutman - Castroviejo

Corneoscleral Scissors
with stop, medium blades, 11.5cm
VH340-1220 right
VH340-1230 left



Castroviejo

Corneal Transplant Scissors
with stop
strong curve, small blades, 11.5cm
VH340-2000 right
VH340-2010 left



Rich

Corneal Transplant Scissors
extremely delicate, strongly
curved blades for trimming the
recipient corneal bed and donor
button. Can also be used for open
sky anterior capsulotomy, 11.5cm
VH340-2014 right
VH340-2015 left



Terry

Micro Corneal Scissors
round handle for
meticulous control, 12cm
VH340-2016 right
VH340-2017 left

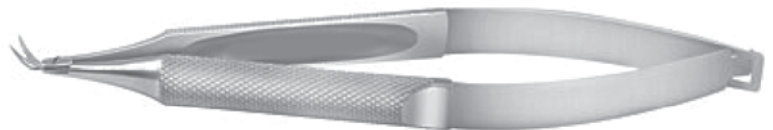

Katzin

Corneal Transplant Scissors
strong curve, medium blades, 11.5cm
VH340-2020 right
VH340-2030 left



Castroviejo

Universal Corneal Scissors
curved, blunt tips, 11.5cm
VH340-2200 small blades
VH340-2220 medium blades
VH340-2240 large blades
VH340-2260 strongly curved

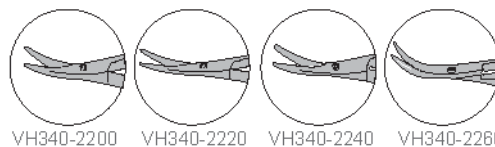

Castroviejo

large blades
Keratoplasty Scissors
angled to side
blunt tips, medium blades, 11.5cm
VH340-2850



SCISSORS

Corneal scissors

curved, 10mm long blades, 11cm
VH340-1464-1 pointed tips curved
VH340-1464-2 blunt tips

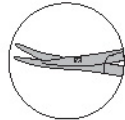

VH340-1464-1



Conjunctival scissors

curved, 10mm long blades, 11cm
VH340-1540-1 pointed tips curved
VH340-1540-2 reverse blades
VH340-1540-3 blunt tips



Conjunctival scissors

curved, 11mm long blades
VH340-1543 blunt tips, 14cm

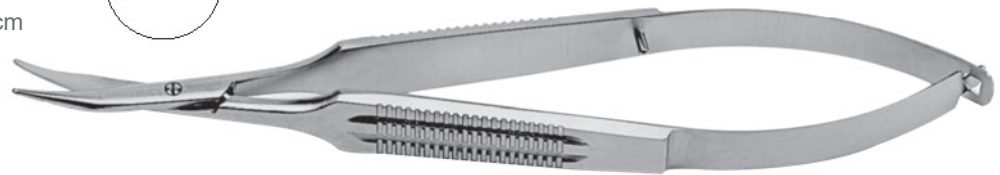
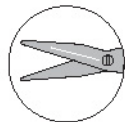

Conjunctival scissors

curved, 8mm long blades
VH340-1546 blunt tips, 11cm

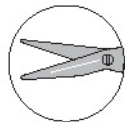

IOL removal scissors

Cutting scissors for removal of
 IOL straight, blunt tips, 8mm long
 with serrated lower blade, 11cm
VH340-1690



IOL removal scissors

Cutting scissors for removal of
 IOL angled, blunt tips, 8mm long
 with serrated lower blade, 11cm
VH340-1691



McPherson - Westcott

Conjunctival Scissors curved
blunt tips, small blades, 11.5cm
VH340-3000

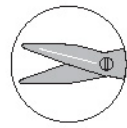

Westcott

Tenotomy Scissors
blunt tips, medium blades
curved, 11.5cm
VH340-3004

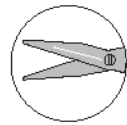

Westcott

Tenotomy Scissors
blunt tips, standard blades curved
VH340-3100 right, 11.5cm
VH340-3110 left, 11.5cm



Tibolt

Punctal Scissors
one conically shaped blade
with micro grooves and
textured surface for simple
"Two-snip Punctoplasty", 11.5cm
VH340-3130

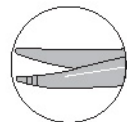

Mini Westcott

Tenotomy Scissors
4mm long curved blades
blunt tips, 8.5CM *20MM Gauge
VH340-3200

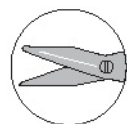

McPherson - Westcott

Stitch Scissors
very sharp pointed
tips small blades curved, 11.5cm
VH340-4000

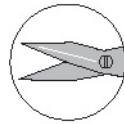

Westcott

Stitch Scissors
very sharp pointed tips
standard blades curved, 11.5cm
VH340-4100

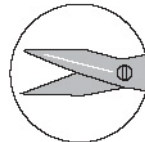

Jaffe

Stitch Scissors
very sharp pointed tips
medium blades curved, 11.5cm
VH340-4150

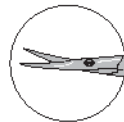

Iris

Scissors
sharp tips, small blades, 11.5cm
VH340-4400 straight
VH340-4410 curved

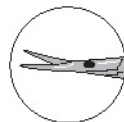

Fine

Stitch Scissors
sharp tips, medium blades, 11.5cm
VH340-4500 straight
VH340-4510 curved

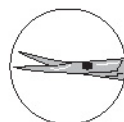

Uthoff

Capsulotomy scissors,
convex curved,
7 mm long, thin blades,
pointed tips, right, 11.5cm
VH340-4240



Fogla Scissors Right

The lower blade is thinner and
1mm longer than the upper blade, 11.5cm
VH340-4241

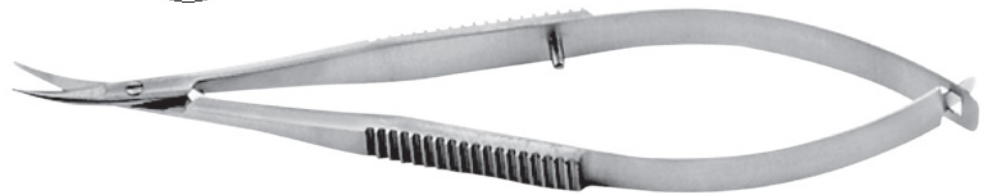

Multipurpose scissors Noyes

Multipurpose scissors Noyes,
straight line, blunt tips, 11.5cm
VH340-4242



Corneal scissors

Corneal scissors, strong, angled,
8 mm long blades, blunt tips, 11.5cm
VH340-4243



Barraquer

Iris Scissors
blunt tips, 7mm long blades, 7cm
VH340-4900



Capsulotomy Scissors Vannas

5mm long blades, sharp tips, 8.5cm
VH340-5000 straight
VH340-5010 curved
VH340-5020 angled forward
VH340-5030 angled to side

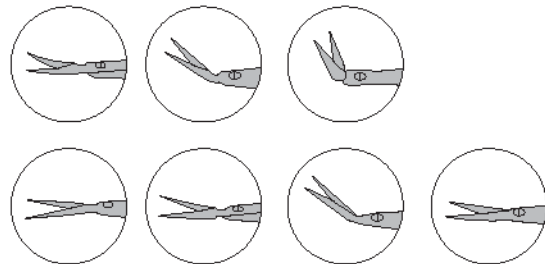

Gills Vannas

7mm long blades, sharp tips, 8.5cm
VH340-5050 straight
VH340-5060 curved
VH340-5070 angled forward



McPherson - Vannas

8mm long blades, sharp tips, 8.5cm
VH340-5100 curved

Capsulotomy Scissors Vannas

7mm extra thin long blades, sharp tips, 11.5cm
VH340-5110 straight
VH340-5111 curved
VH340-5112 angled forward

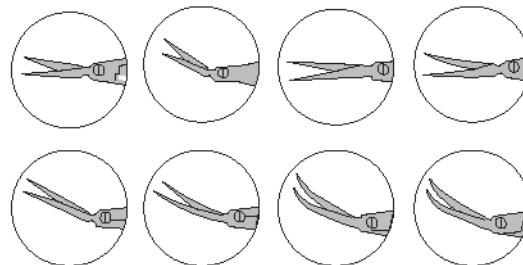

10mm extra thin long blades, sharp tips, 11.5cm
VH340-5120 straight
VH340-5121 curved
VH340-5122 angled forward
VH340-5123 curved, angled, forward

10mm long angled blades, curved tips, 11.5cm
VH340-5125 sharp points
VH340-5126 blunt points



Eye Scissors

pointed tips small, 9cm
VH340-7200 straight
VH340-7210 curved

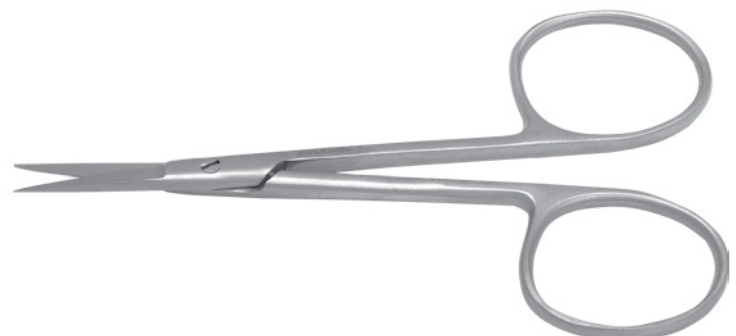

Eye Scissors

pointed tips

standard, 11.5cm

VH340-7400 straight

VH340-7400TC Tungsten Carbide str

VH340-7400SC Super Cut str

VH340-7410 curved

VH340-7410TC Tungsten Carbide cvd

VH340-7410SC Super Cut cvd

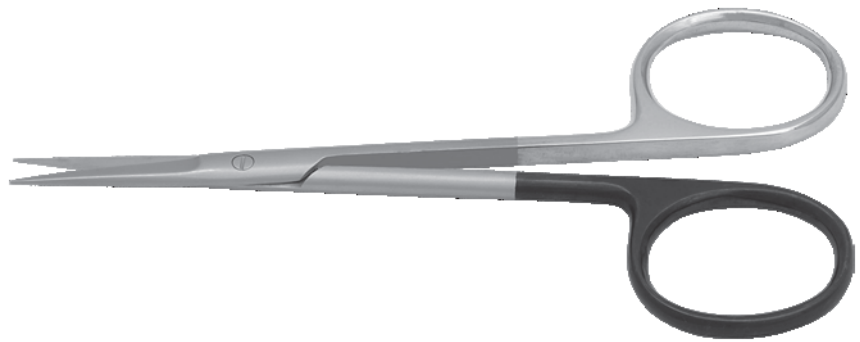

Eye Scissors

large rings

pointed tips

standard, 11.5cm

VH340-7440 straight

VH340-7450 curved

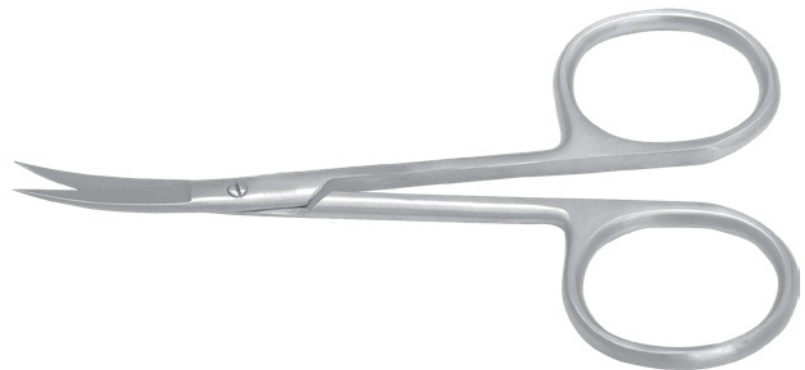

Stitch Scissors

ribbon type

needle points curved, 11.5cm

VH340-8000

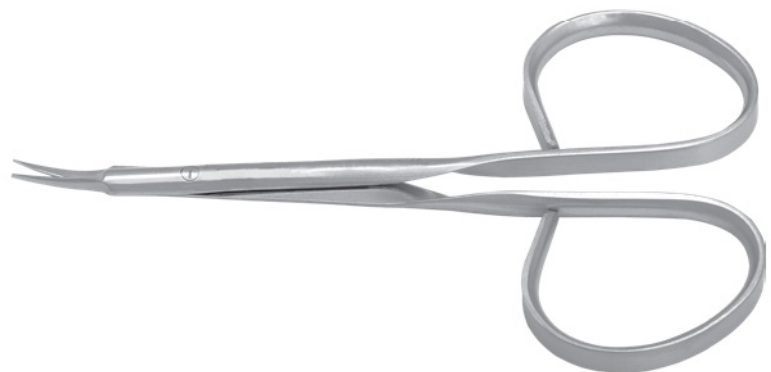

Stitch Scissors

needle points

light curve, 11.5cm

VH340-8100



Stevens

Tenotomy Scissors
blunt tips
standard, 11.5cm

VH340-8500 straight

VH340-8500TC Tungsten Carbide str

VH340-8500SC Super Cut str

VH340-8510 curved

VH340-8510TC Tungsten Carbide cvd

VH340-8510SC Super Cut cvd



Stevens

Tenotomy Scissors
ribbon type blunt tips, 11.5cm

VH340-8520 straight

VH340-8530 curved

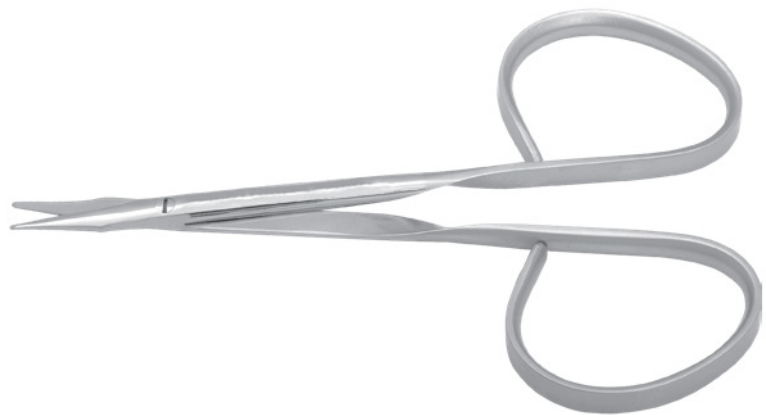

Knapp

Strabismus Scissors
blunt tips, 11.5cm

VH340-9000 Straight

VH340-9000TC Tungsten Carbide str

VH340-9000SC Super Cut str

VH340-9010 curved

VH340-9010TC Tungsten Carbide cvd

VH340-9010SC Super Cut cvd

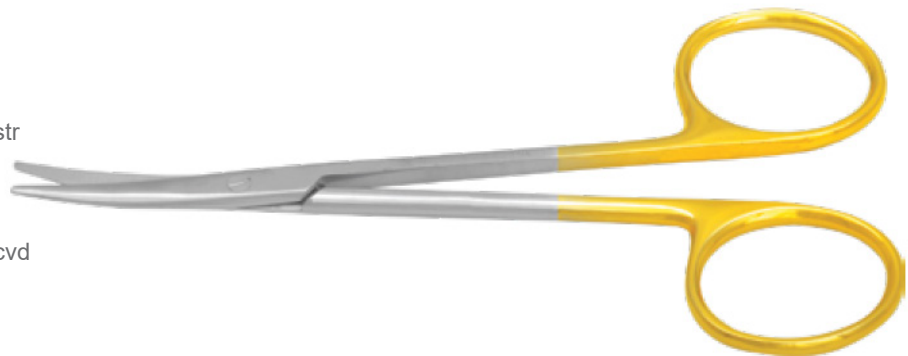

Strabismus Scissors

ribbon type
blunt tips, 11.5cm

VH340-9020 straight

VH340-9030 curved

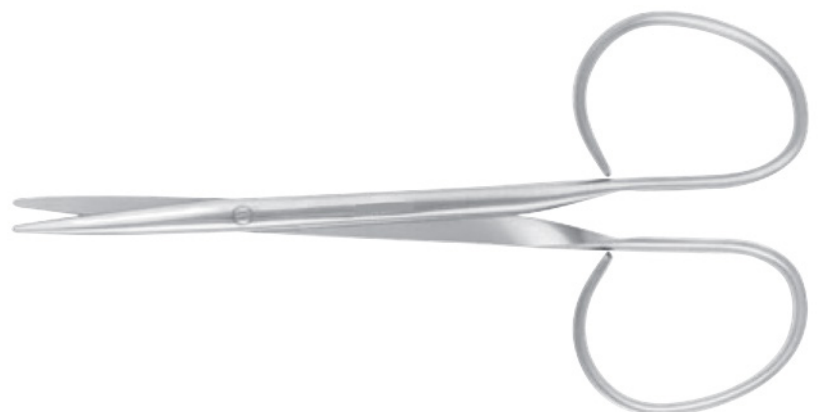

Metzenbaum

Dissecting Scissors
gently curved blades
blunt tips 5 3/4" (14.5cm)
long, 14cm

VH340-9040

VH340-9040TC Tungsten Carbide

VH340-9040SC Super Cut



Utility Scissors

one pointed and one
blunt tip
5 3/4" (14.5cm) long
straight, 14cm

VH340-9060

VH340-9060TC Tungsten Carbide

VH340-9060SC Super Cut



Enucleation Scissors

blunt tips, 14cm
VH340-9910 medium curve
VH340-9920 strong curve

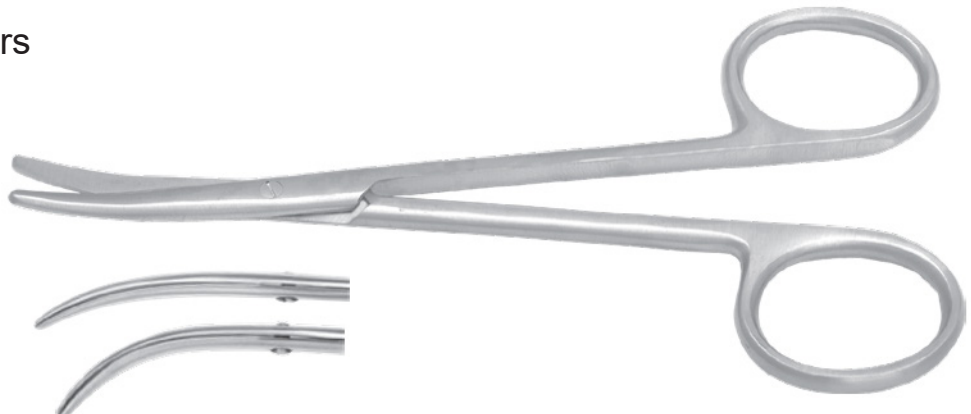

Black Coated Super Cut Scissors

black coated super cut Iris scissors, 11.5cm

VH340-7400SCB Str

VH340-7410SCB Cvd



VeHtu

SALES & PRODUCTION

VH350

• **Forceps**

VeHtu
SALES & PRODUCTION

ICL forceps

ICL forceps for loading, angled tips, 15cm
VH350-75666 S.S
VH350-75666T titanium



Foldable Lens Cutter Squeeze

Titanium Handle 112mm, 15cm
VH350-4-21731T titanium



IOL Lens Cutter

IOL Lends cutter/Holder with one serrated blade stainless steel, 15cm
VH350-0787T titanium

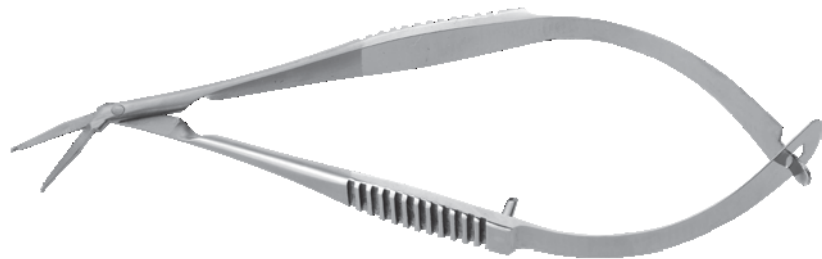

Foldable Lens Removing Forceps

Titanium Handle 110mm, 15cm
VH350-4-21741T titanium



Vitreo - Retinal Forceps

Stainless Steel Autoclavable, 15cm



smooth jaws
20 gauge, straight
VH350-7499 20G/0.9



Stainless Steel Autoclavable



Subretinal Forceps
Angled 135°,
4.5mm from the tip
VH350-7500 20G/0.9



Serrated jaws
straight
VH350-7501 20G/0.9
VH350-7502 23G/0.6



ILM Forceps
2.2mm long with
shaft size 27.5mm
VH350-7503 20G/0.9
VH350-7504 23G/0.6



End gripping forceps
straight
VH350-7505 20G/0.9
VH350-7506 23G/0.6



Serrated ILM
Forceps, 1.25mm
Long – with fine pick.
VH350-7507 20G/0.9
VH350-7508 23G/0.6



Spaide Pic forceps,
VH350-7510 20 G/0.9
VH350-7511 23 G/0.6



Asymmetrical
End-gripping Forceps,
VH350-7512 20 G/0.9
VH350-7513 23 G/0.6



Eckardt End-gripping
Forceps,
VH350-7514 20 G/0.9
VH350-7515 23 G/0.6



ILM forceps,
VH350-7516 20 G/0.9
VH350-7517 23 G/0.6

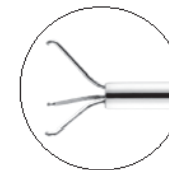

Foreign Body Forceps
Basket style with three
gripping arms.
VH350-7518 20 G/0.9

Vitreo - Retinal Forceps

15cm



Subretinal Forceps
Angled 135°,
4.5mm from the tip
VH350-7500T 20G/0.9
titanium



ILM Forceps
2.2mm long with
shaft size 27.5mm
VH350-7503T 20G/0.9
VH350-7504T 23G/0.6
titanium



Serrated ILM
Forceps, 1.25mm
Long – with fine pick.
VH350-7507T 20G/0.9
VH350-7508T 23G/0.6
titanium



Serrated jaws
straight
VH350-7501T 20G/0.9
VH350-7502T 23G/0.6
titanium



End gripping forceps
straight
VH350-7505T 20G/0.9
VH350-7506T 23G/0.6
titanium



Spaide Pic forceps,
VH350-7510T 20 G/0.9
VH350-7511T 23 G/0.6
titanium



Eckardt End-gripping
Forceps,
VH350-7514T 20 G/0.9
VH350-7515T 23 G/0.6
titanium

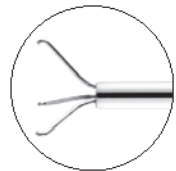

Foreign Body Forceps
Basket style with three
gripping arms.
VH350-7518T 20 G/0.9
titanium



Asymmetrical
End-gripping Forceps,
VH350-7512T 20 G/0.9
VH350-7513T 23 G/0.6
titanium



ILM forceps,
VH350-7516T 20 G/0.9
VH350-7517T 23 G/0.6
titanium

TITANIUM RETINAL FORCEPS

Micro Capsulorhexis Forceps

Capsulorhexis forceps 4mm long jaws with angled, grasping platform. Curved shaft 24mm long, 15cm

VH350-7651 21G/0.8 S.S

VH350-7651T 21G/0.8 titanium

VH350-7652 23G/0.6 S.S

VH350-7652T 23G/0.6 titanium

Ikeda Capsulorhexis forceps

0.6mm (23G) Delicate 1.2mm long jaws with angled, grasping platform, 15cm

Curved shaft 24mm

VH350-7653 S.S

VH350-7653T titanium



Ikeda angled micro Capsulorhexis

0.9mm long jaw with 90° angled, grasping platform.

Strongly curved shaft 24mm, 15cm

VH350-7654 S.S

VH350-7654T titanium

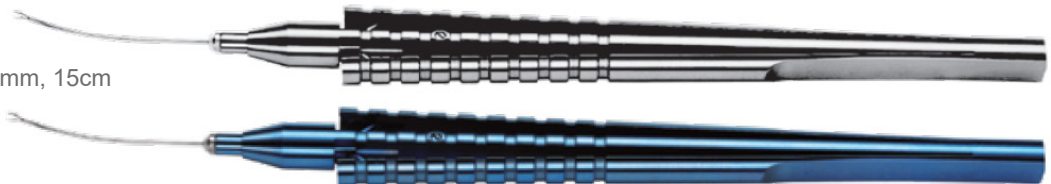

23 G MICS/MCCS Coaxial Capsulorhexis Forceps

MICS/MCCS Capsulorhexis 23G

1.3 mm jaws, for 1 mm incisions, 15cm

VH350-600001T titanium



MICS Capsulorhexis Forceps

VH350-7655

23G Ikeda capsulorhexis forceps 0.65 mm delicate 1.2 mm long jaws with angled, 15cm grasping platform, curved shaft

VH350-7656T titanium

23G komaki micro capsulorhexis forceps

universal capsulorhexis forceps 0.7 mm long jaws with 90° angled grasping platform, 15cm

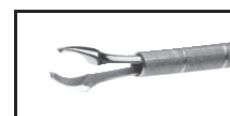

Botvin

Iris Forceps

For peripheral iridectomies.

VH350-1040 serrated tips, 15cm

VH350-1050 1x2 teeth, 7.5cm



Colibri Style

very delicate, 1x2 teeth, 0.12mm, 7.5cm

VH350-1500 Colibri

VH350-1520 Harms-Colibri, with tying platform

VH350-1520T Harms-Colibri, with tying platform, titanium

VH350-1522 Dyson-Colibri, short tips, extremely thin shanks, with tying platform Standard, 1x2 teeth with tying platform

VH350-1550 Colibri, 0.4mm Corneal Suturing Forceps delicate, 1mm spread, 1x2 teeth, 0.12mm, 7.5cm

VH350-1560 Polack Corneal Forceps

very delicate, 1x1 teeth, 0.1mm, 9cm

VH350-1700 Pierse-Colibri

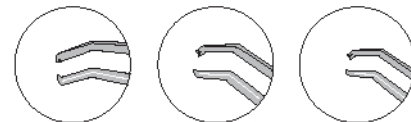

VH350-1500

VH350-1520

VH350-1522



VH350-1550

VH350-1560

VH350-1700



Gills - Colibri

Tissue Forceps

very fine pointed tips

with tying platform, 7.5cm

VH350-1450

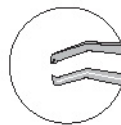

Colibri - Forceps

Colibri corneal forceps,

delicate, 1x2 straight,

with tying platform, 7.5cm

VH350-118950-1 0.12 mm

VH350-118950-2 0.40 mm

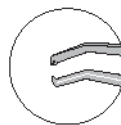

Harms

VH350-118950-3 0.12 mm teeth,

with tying 1x2 oblique

Hoskin

Tissue Forceps, straight, 9cm

VH350-1718 #18, fine grooved tips

VH350-1719 #19, micro grooved tips

VH350-1728 #28, very delicate, micro grooved tips

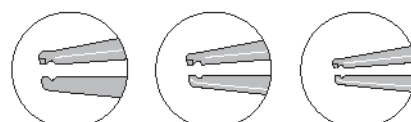

VH350-1718

VH350-1719

VH350-1728



FORCEPS

Hoskin

Tissue Forceps,
Colibri style, 9cm

VH350-1722 #22, micro grooved tips

VH350-1730 #30, very delicate micro
grooved tips

VH350-1734 #34, pointed tips

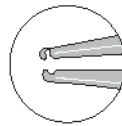

VH350-1722

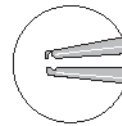

VH350-1730



VH350-1734



Pierse

Corneal Forceps
very delicate 1x1 teeth,
0.1mm straight, 9cm

VH350-1800

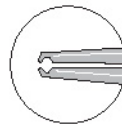

Fechtner

Conjunctiva Forceps
very delicate ring shaped
tips with tying platform, 10cm

VH350-1820

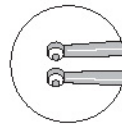

Castroviejo - Colibri

1x2 teeth, 0.12mm, 11cm

VH350-1900

Harms 1x2 teeth, 0.12mm with tying platform, 11cm

VH350-1902

Hyde 2x2 teeth, 0.12mm with tying platform, 11cm

VH350-1920

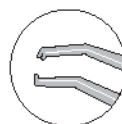

Hoskin

Tissue Forceps, curved

VH350-1716 #16, fine grooved tips, 9cm



Bonn

French pattern bonn forceps
0.1 mm with tying
VH350-7850A 11cm long handle
VH350-7835 7.5cm short handle
VH350-7835T 7.5cm **titanium**

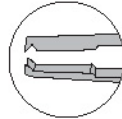

Bonn

Forceps
very delicate 1x2 teeth, 0.12mm, 8.5cm
VH350-2000
VH350-2010 with tying, 10cm

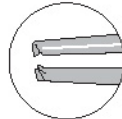

Bonn

Forceps
1x2 teeth, 0.12mm
with tying platform, 10cm
VH350-2020 S.S
VH350-2020T **titanium**

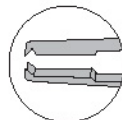

Thorpe

Corneal Forceps
2x3 teeth, 0.12mm
with tying platform, 10cm
VH350-2100

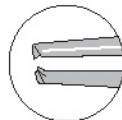

Colibri Corneal Forceps

Colibri Corneal Forcep
with tying platform titanium 9cm
VH350-500095T 0.10 1x2 **titanium**
VH350-500095-1T 0.30 1x2 **titanium**

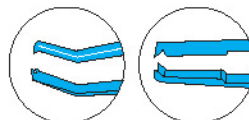

Bonn Corneal Forceps

Bonn Corneal Forcep
delicate, 1x2 straight 0.12mm teeth
with tying platform, 11cm
VH350-500093

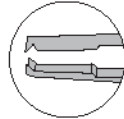

Corneal Forceps

Corneal Forcep
delicate, 1x2 straight 0.12mm teeth
with tying platform, ergonomic handle, 11cm
VH350-500094

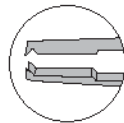

Corneal Forceps

Corneal Forcep 1x2 delicate w/tying
platform titanium ergonomic handle, 10cm
VH350-500096T 0.10 titanium
VH350-500096-1T 0.30 titanium
VH350-500096-2T 0.10 oblique titanium
VH350-500096-3T 0.30 oblique titanium

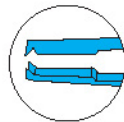

Corneal Forceps

Corneal Forceps 90mm titanium, 9.5cm
VH350-500097T 0.12 1x2 titanium
VH350-500097-1T 0.3 1x2 titanium
VH350-500097-2T 0.12 1x2 oblique titanium
VH350-500098T 0.3 notched titanium
Plain tying forceps
VH350-500098-1T 5mm titanium

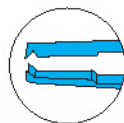

Kelmann McPherson

Kelmann Forcep 90mm titanium, 9.5cm
VH350-600009T tying Ang 9mm titanium
VH350-600009-1T tying Ang 7mm titanium
VH350-600009-2T tying Ang 11mm titanium



Iris Forceps

Iris forceps, 1x2 straight,
0.20 mm teeth, with tying platform, 7cm
VH350-700006

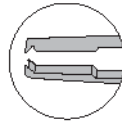

Corneal forceps

Corneal forceps, delicate, 1x2 straight
0.12 mm teeth, with tying platform, 11cm
VH350-13160
VH350-13160T titanium

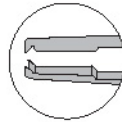

Conjunctival and Fixation Forceps

Conjunctival and fixation, forceps
1x2 straight, 0.50 mm teeth, 11cm
VH350-700008

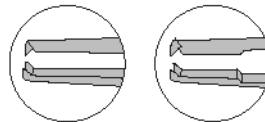

Scleral forceps, straight,
1x2 straight 0.70 mm teeth, with tying platform, 10cm
VH350-700009



Conjunctival and Fixation Forceps

Conjunctival and fixation, forceps
1x2 straight, 0.50 mm teeth, 7cm
VH350-700010

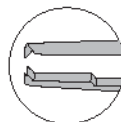

Suturing forceps

Suturing forceps, straight,
1x2 oblique teeth, with tying platform, 10cm
VH350-700011-1 0.12mm
VH350-700011-2 0.35mm
VH350-700011-3 0.60mm
VH350-700011-4 0.90mm

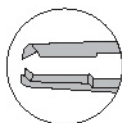

Jayle Corneal Tying Forceps

VH350-5505 0.15mm teeth, 11cm

VH350-5506 0.3mm teeth, 11cm

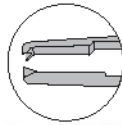

Jayle Corneal Tying Forceps

VH350-5507T 0.12mm teeth, 11cm titanium

VH350-5508T 0.3mm teeth, 11cm titanium

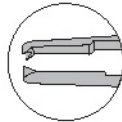

St.Martin Corneal Tying Forceps

VH350-5509 0.15mm teeth, 9cm

VH350-5510 0.3mm teeth, 9cm

VH350-5511T 0.15mm teeth, 9cm titanium

VH350-5512T 0.3mm teeth, 9cm titanium

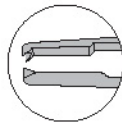
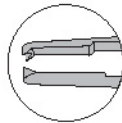

Bonn Micro Tying Forceps

VH350-5513

corneal 0.12mm teeth, 11cm

VH350-5514T

corneal 0.12mm teeth, 11cm titanium

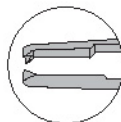
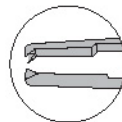
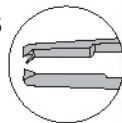

VH350-5515

iris 0.12mm teeth, 7cm

VH350-5516T

iris 0.12mm teeth, 7cm titanium

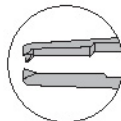

McPherson

Tissue Forceps
1x2 teeth, 0.4mm with tying platform, 10cm
VH350-2300 straight
VH350-2310 angled
8mm long 1x2 teeth, 0.3mm
VH350-2330 angled

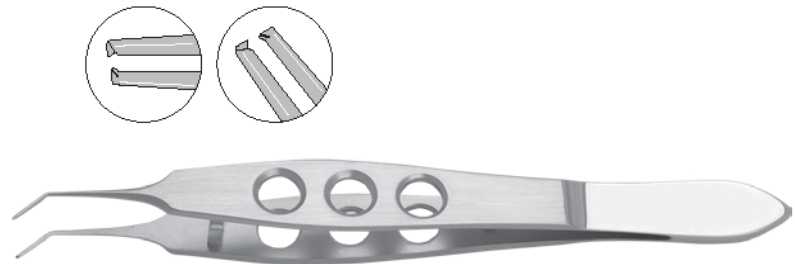

Hoffer - McPherson

Forceps very delicate
11mm long jaws
1x2 teeth, 0.12mm, 10cm
VH350-2350

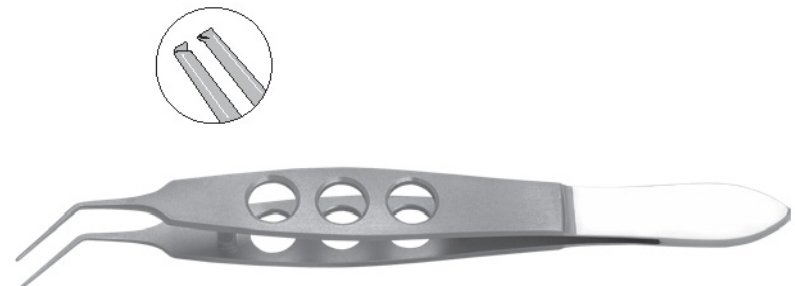

Castroviejo Suturing Forceps

1x2 teeth with tying platform, 10cm
VH350-2500 0.12mm
VH350-2510 0.3mm
VH350-2520 0.5mm
VH350-2530 0.9mm
VH350-2500T 0.12mm, titanium



Castroviejo Suturing Forceps

1x2 teeth with tying platform, 11cm
VH350-25500 0.12mm
VH350-25501 0.3mm
VH350-25502 0.5mm
VH350-25503 0.9mm
VH350-25504T 0.12mm, titanium

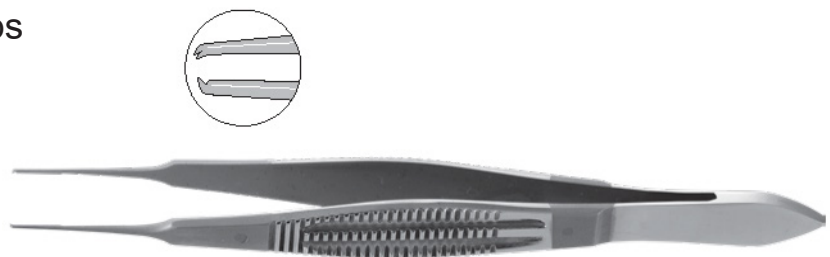

Castroviejo Suturing Forceps

1x2 teeth with tying platform, 11cm
VH350-25300 0.12mm
VH350-25300-1 0.3mm
VH350-25300-2 0.5mm
VH350-25300-3 0.9mm

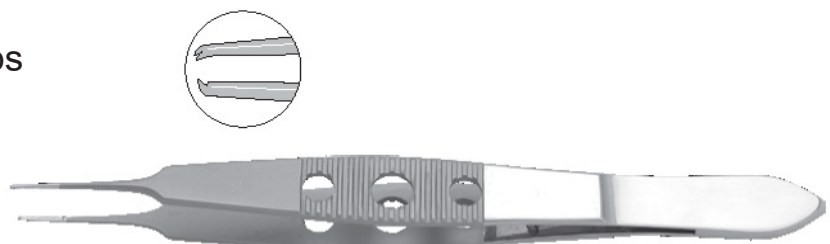

Moody

Fixation Forceps
1x2 teeth, 0.5mm
with lock, 11cm
VH350-2553 left
VH350-2554 right

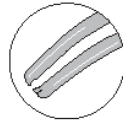

Castroviejo-Colibri

Castroviejo-Colibri
type corneal forceps 0.12mm, 1x2, 11cm
VH350-1930

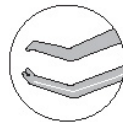

Girard

Corneoscleral Forceps
1x2 teeth, 0.12mm
with tying platform, 11cm
VH350-2900 right hand
VH350-2910 left hand

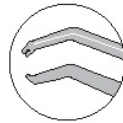

Stern - Castroviejo

Fixation Forceps
1x2 teeth, 0.5mm with lock, 11cm
VH350-2552

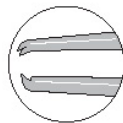

Bores

Corneal Fixation Forceps
U - Shaped, 3mm spread
1x2 teeth at each tip, 0.12mm, 11cm
VH350-3250



Bishop - Harmon

Tissue Forceps

1x2 teeth, 8.5cm

VH350-3500 delicate

VH350-3510 standard

VH350-3520 heavy

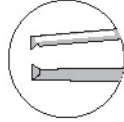

Bishop - Harmon

Dressing Forceps, 8.5cm

VH350-3550 criss-cross serrated tips

VH350-3550-1 serrated 0.5

VH350-3550-2 serrated 0.8

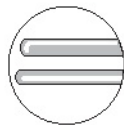

Fixation Forceps

1x2 teeth, 0.3mm, 9cm

VH350-3560 sauer

VH350-3562 manhattan Eye & Ear
with tying platform

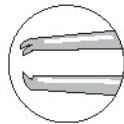

Dressing Forceps

Serrated, delicate, 11cm

VH350-4000 straight

VH350-4010 curved



Tissue Forceps

1x2 teeth, , 11cm

VH350-4100 delicate, straight

VH350-4110 delicate, curved

VH350-4140 standard, straight

VH350-4141 standard, curved

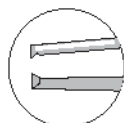

Adson

straight, 5" (125mm) long, 12.5cm

VH350-4150 serrated jaws, delicate

VH350-4152 serrated jaws, standard

VH350-4170 1x2 teeth, delicate

VH350-4172 1x2 teeth, standard

VH350-4152T serrated **titanium**

VH350-4170T 1x2 delicate **titanium**

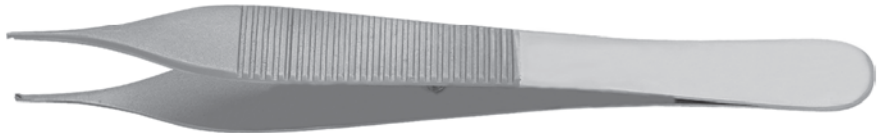
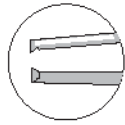

Bayonet

Dressing Forceps serrated jaws

5 3/4" (146mm) long, 13cm

VH350-4180



Lester

Fixation Forceps straight, 9cm

VH350-4300 1x2 teeth

VH350-4320 2x3 teeth



Fixation Forceps

1x2 teeth, 9cm

VH350-4500 Bracken delicate teeth

VH350-4550 Elschmig, standard teeth



Troutman

Superior Rectus

Forceps 1x2 teeth angled, 10cm

VH350-4700



Tying Forceps

For 8-0 to 11-0 sutures forceps

McPherson, 10cm

VH350-5000 5mm long tying straight

VH350-5000T 5mm long tying straight, titanium

VH350-5010 5mm long tying angled

VH350-5010T angled, 5mm long tying titanium

Kelman - McPherson forceps

VH350-5030 7.5mm long tying angled

VH350-5030T 7.5mm long tying angled, titanium

Bechert Forceps

VH350-5049 10mm long tying angled

Gaskin Forceps

VH350-5050 11mm long tying angled

VH350-5050T 11mm long tying angled, titanium

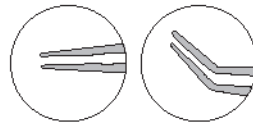

VH350-5000 VH350-5010

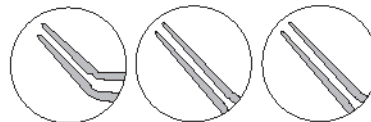

VH350-5030 VH350-5049 VH350-5050



Haberle - McPherson

Lens Holding Forceps

7.5mm long jaws

with groove, angled

For grasping IOL haptic, 10cm

VH350-5040

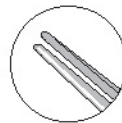

Kurstin

Flap Stretching Forceps

disc shaped

serrated jaws

Designed for stretching

the flap to eliminate striae, 10cm

VH350-5056

LASIK Flap Forceps

disc shaped

serrated jaws, 10cm

VH350-5058

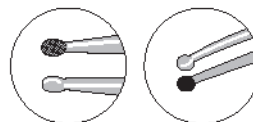

VH350-5056 VH350-5058



Inamura

Capsulorrhexis Forceps
delicate tapered shanks
to seal the incision during
continuous curvilinear
capsulorrhexis
Excellent for MICS, 10cm
VH350-5070

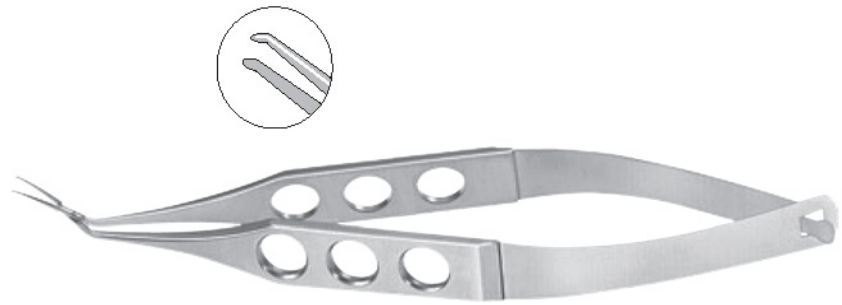

Utrata

Capsulorrhexis Forceps
very delicate, short handle
triangular grasping tips
extremely thin
with landmarks at 2.5mm and
5.0mm, 8.5cm
VH350-5071 straight



Masket

Capsulorrhexis Forceps
very delicate, short handle
triangular grasping tips
extremely thin
with landmarks at 2.5mm and
5.0mm, 8.5cm
VH350-5074 vaulted



Kraff

Capsule Tag Forceps
11mm long shanks
1.5mm long grasping tips, 10cm
VH350-5080

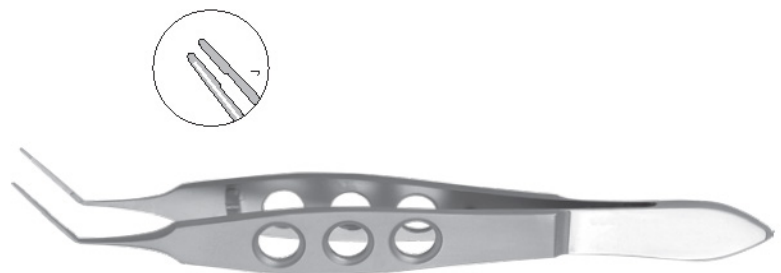

Utrata Capsulorhexis Forceps

Sharp Tips, 80mm, 8.5cm
VH350-2002S



Utrata

Capsulorrhexis Forceps
very delicate
triangular grasping tips
extremely thin
11mm long shanks, 10cm
VH350-5081 stainless steel
VH350-5081T titanium



Utrata

Capsulorrhexis Forceps
very delicate
triangular grasping tips
extremely thin
11mm long shanks
round handle with guide pin
for alignment, 11cm
VH350-5082



Nevyas

Capsulorrhexis Forceps
cystotome shaped tips
extremely thin
11mm long shanks
For tearing and grasping
the anterior capsule, 10cm
VH350-5083 stainless steel
VH350-5083T titanium



Masket

Capsulorrhexis Forceps
very delicate
triangular grasping tips
extremely thin 11mm long
vaulted shanks, 10cm
VH350-5084
VH350-5084T titanium



Inamura

Capsulorrhexis Forceps
round handle cross action
2 mm incision, 12cm
VH350-50070

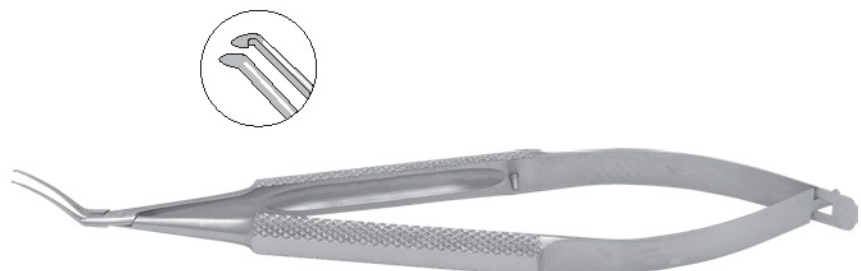

FORCEPS

Masket

Capsulorhexis Forceps
very delicate triangular
grasping tips extremely
thin 11mm long vaulted
shanks round handle with
guide pin for alignment, 11cm
VH350-5086
VH350-5086T titanium



Capsulorhexis Forceps

Corydon forceps
ergonomic curved, cystotome tips,
12 cm long
VH350-17163



Capsulorhexis Forceps

angled, 12 mm graduated slightly curved
arms, sharp tips, ergonomic handle, 10cm
VH350-600002 11mm angled
VH350-600003 12mm angled



Capsulorhexis Forceps

Round handle
11mm long shanks straight, 12cm
VH350-405081



Capsulorhexis Forceps

Round handle, curved,
cystotome tips, 12cm long
VH350-500091



Inamura Capsulorhexis Forceps

Sharp pointed serrated tips angled 90° from shaft
Curved shaft, tip to pivot point 8.5mm
Cross action tips, 1.2mm width at pivot box, 11cm
Round handle, overall length 111mm desired size of capsulorhexis

VH350-00786T titanium

VH350-00786-1T titanium marks on shaft at 2.5mm and 5.0mm denote

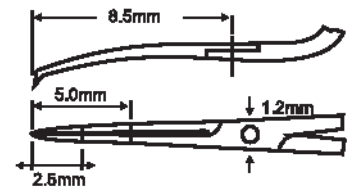

Capsulorhexis Forceps

Capsulorhexis forceps, 11cm
Capsulorhexis forceps, lightweight,
angled, 12 mm, slightly curved arms,
sharp tips,

VH350-80001234T titanium

Capsulorhexis forceps, lightweight,
angled, 12 mm, slightly curved arms,
strongly angled, sharp tips,

VH350-80001234-1T titanium

Capsulorhexis forceps, lightweight,
angled, 11 mm, slightly curved arms,
notched tips

VH350-80001234-2T titanium

Capsulorhexis forceps, lightweight,
angled, 11 mm, slightly curved arms,
sharp, strongly angled tips

VH350-80001234-3T titanium

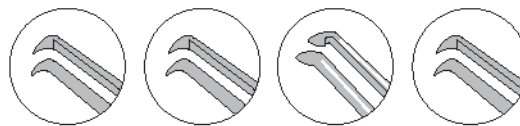

Capsulorhexis forceps

Capsulorhexis forceps, angled,
11 mm slightly curved arms, sharp,
notched tips, 10cm

VH350-700003



Capsulorhexis forceps

Capsulorhexis forceps, angled,
11 mm slightly curved arms, sharp tips
ergonomic handle, 11cm

VH350-700002T titanium



Capsulorhexis forceps

Capsulorhexis forceps
flat handle, 11 mm sharp tips,
micro incision, 11cm
VH350-700001T titanium



MICS capsulorhexis forceps

MICS capsulorhexis forceps,
controlled opening for 2 mm incisions, 11cm
VH350-700018T titanium



**Capsulorhexis Forceps
for micro coaxial phaco**

Capsulorhexis forceps with 2mm
controlled opening for 2mm incisions, 11cm
VH350-500099T titanium



MICS/MCCS Capsulorhexis Forceps

MICS/MCCS Capsulorhexis
with 2 mm controlled opening,
for 2 mm incisions, 11cm
VH350-600000



Capsulorhexis Forceps

extremely delicate, 10cm
VH350-31300



Prechopper

Combo Prechopper,
for grades 1-4 nuclei,
2 mm opening, sharp top side, 11cm
VH350-600005-1



Prechopper

Akahoshi Super Combo III Prechopper
For nucleus grades 1 to 3.
is suitable for the vertical Karate
Prechop technique within a 2mm incision.
Prechopping can be completed without
nuclear support for nuclei grade 1 to 3, 12cm
VH350-7233

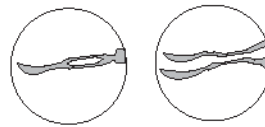

Akahoshi Hybrid Combo prechopper
For Grades 1-4 Nuclei, 12cm
VH350-7235

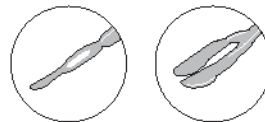

Akahoshi Universal Nucleus Splitter, 12cm
VH350-7236

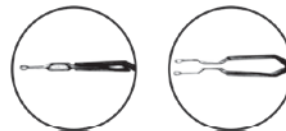

Akahoshi

Phaco PreChopper
4.5mm long delicate jaws
with sharp tips
For cracking, dividing and rotating
the nucleus without sculpting, 12cm
VH350-7230



Akahoshi

Combo PreChopper
For cracking, dividing and rotating
both hard and soft nuclei without
sculpting, 12cm
VH350-7232



Anis

Tying Forceps
extra delicate
smooth jaws
For 9-0 to 11-0 sutures, 11cm
VH350-5112 straight
VH350-5113 curved

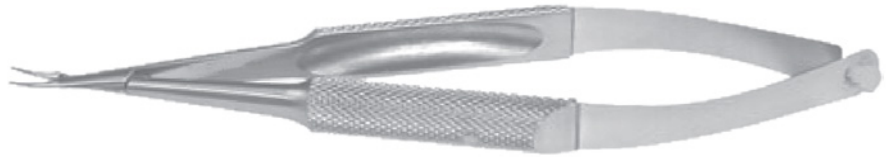

Freeman - Jaffe

Lens Holding Forceps
with longitudinal groove
For grasping IOL haptic, 11cm
VH350-5190

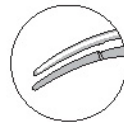

Jaffe

Tying Forceps
very delicate
smooth jaws
6mm long platform
For 8-0 to 11-0 sutures, 10cm
VH350-5200 straight
VH350-5210 curved
VH350-5200T straight **titanium**
VH350-5210T curved **titanium**

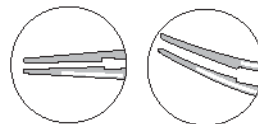

Gerl

Tying Forceps
curved shanks
6mm long platform
For 8-0 to 11-0 sutures, 10cm
VH350-5215T **titanium**

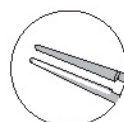

Tennant

Tying Forceps
extra delicate smooth jaws
with 6mm long platform
round handle with guide pin
For 9-0 to 11-0 sutures, 11cm
VH350-5220 straight
VH350-5220T straight, **titanium**
VH350-5230 curved
VH350-5230T curved, **titanium**

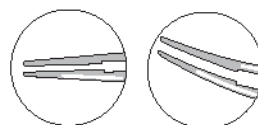

Maumenee

Tying Forceps
concave-convex jaws
round handle with guide pin
For 8-0 to 11-0 sutures, 11cm
VH350-5234T straight titanium
VH350-5235T angled titanium
VH350-5234 straight
VH350-5235 angled



Jaws Cross Section



Harms

Tying Forceps
standard, smooth jaws
for 7-0 to 9-0 sutures, 10cm
VH350-5400 straight
VH350-5410 curved
VH350-5400T straight titanium
VH350-5410T curved titanium

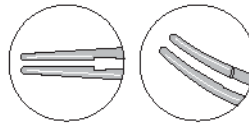

Tuebingen Model

Tying forceps straight, 10cm
VH350-19030 S.S
VH350-19030T titanium

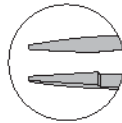

Tuebingen Model

Tying forceps curved, 10cm
VH350-19040 S.S
VH350-19040T titanium

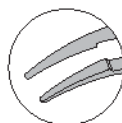

McPherson Tying Forcep

Recommended for 8-0 to 10-0 sutures, 10cm
VH350-700019 4mm tying straight
VH350-700019-1 4mm tying curved
VH350-700019-2 4mm tying angled
VH350-700019-3 8mm tying angled

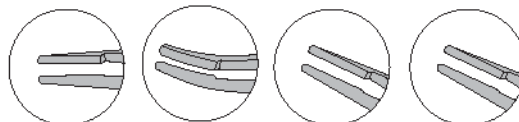

FORCEPS

Kelmann Forceps

Kelmann forcep angled
ergonomic handle

VH350-600007 11 mm tying, 10cm

VH350-600007-1 7 mm tying, 12cm



Troutmann Forceps

Troutmann forcep very delicate
ergonomic handle

VH350-600075 7 mm tying str, 12cm

VH350-600008 7 mm tying cvd, 12cm



Troutman Forceps

VH350-9604 Straight, delicate, bullet shape, 10cm

VH350-9605 Curved, delicate, bullet shape, 10cm

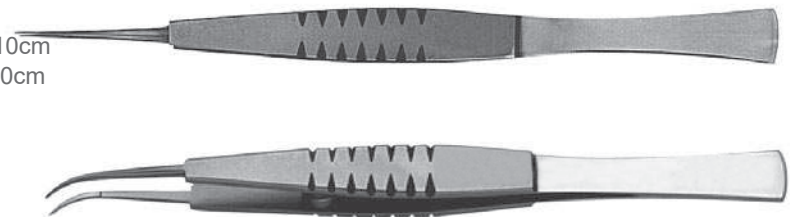

IOL Loading Forceps

Loading forceps for foldable lenses
into the cartridge, 11 mm angle to tip,
cylindrical arms, 11cm

VH350-700014T titanium



Golf ball tying Forceps

Golf ball tying forcep titanium, 11cm

VH350-700016-1T angled 8mm titanium

VH350-700016-2T straight 5mm titanium

VH350-700016-3T curved 5mm titanium

VH350-700016-4T delicate str 5mm titanium

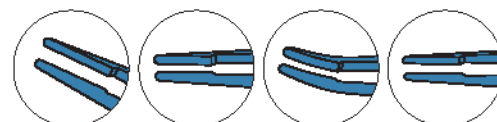

Tying Forceps

Troutman forceps 6mm, 11cm

VH350-55410 straight

VH350-55420 curved

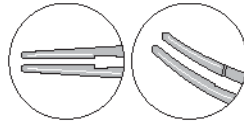

Kelman McPherson

French pattern tying forceps

11mm angled, 11cm

VH350-500088

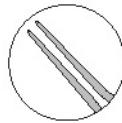

Mc Pherson

VH350-511188 Tying Forceps 5mm str, 10cm

VH350-500089 Tying Forceps 5mm angled, 10cm

VH350-500090 Tying Forceps 10mm angled, 10cm

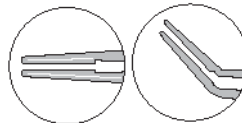

Fixation Forceps

Fixation forceps, straight,

VH350-700012-1 3mm, 10cm

VH350-700012-2 4mm, 11cm

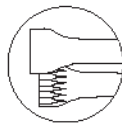

Green Fixation Forceps

Green fixation forceps, 11cm

VH350-700013



Helveston

Tying Forceps
standard, smooth jaws
For 4-0 to 6-0 sutures, 10cm
VH350-5420

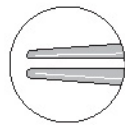

Fine

Tying Forceps
standard, smooth jaws
For 7-0 to 9-0 sutures, 10cm
VH350-5550

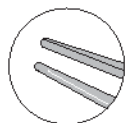

Arita

Meibomian Gland Compressor
broad, smoothly polished jaws, 11cm
VH350-5900



Cilia Forceps with spring tension

VH350-6205 12cm
VH350-6205T 12cm titanium



Barraquer

Cilia Forceps lightly angled
Textured jaws provide
superior grasping capabilities, 10cm
VH350-6000



Barraquer Cilia Forceps

Barraquer Cilia Forceps, 10cm
VH350-6001



Beer Forceps Cilia

VH350-9300 10cm



Cilia Forceps

Cilia Forceps
slanted jaws gold plated, 10cm
VH350-6020



Gradle

Cilia Forceps smooth jaws, 10cm
VH350-6100

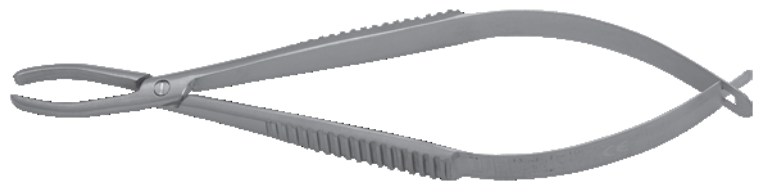

Bonaccolto

Conjunctiva Forceps
longitudinally serrated jaws
with cross serrations at tips, 11cm
VH350-6200 1.2mm wide
VH350-6210 1.7mm wide

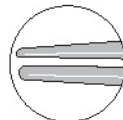

Giannetti

MICS Capsulorrhexis Forceps
ultra delicate shanks and tips
maximum jaw opening 1.75mm
For performing capsulorrhexis
through a micro incision, 12cm
VH350-5090

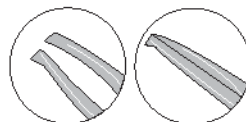

Moorfields Conjunctival Forceps

VH350-5500F standard, 10.5cm

VH350-5501F fine, 10.5cm

VH350-5500FT standard, 10.5cm titanium

VH350-5501FT fine, 10.5cm titanium



Stallard Tying Forceps

VH350-5502, 12cm

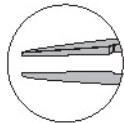

Rycroft Corneal Tying Forceps

VH350-5503 plain, 12cm

VH350-5504 0.3mm teeth, 12cm

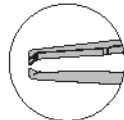
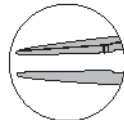

Scleral Plug Forceps

VH350-5517 12cm



Vessel Dilator

11 cm long, flat handle 9 mm wide,
angulated 10°, 11cm
VH350-6590 st



Micro Forceps

15 cm long, round handle, 14cm
VH350-6591 st 6mm tying 1x2, 0.30 straight
VH350-6592 st 6mm tying straight
VH350-6593 st 6mm tying curved
VH350-6594 st vessel dilator



Nugent

Utility Forceps, 10cm
VH350-6214 smooth jaws
VH350-6215 serrated jaws



Foreign

Body Forceps straight, 8cm
VH350-6400



Utility & Splinter

Forceps pointed, short jaws
Suitable for epilation, 8cm
VH350-6500 #H



Jewelers

Forceps
standard, straight, 11cm
VH350-6510 #1



Jewelers

Forceps
delicate, straight, 10cm
VH350-6520 #3-C



Jewelers

Forceps
delicate, straight, 11cm
VH350-6530 #3



Jewelers

Forceps
delicate, straight, 11cm
VH350-6540 #4



Jewelers

Forceps
extra delicate, straight, 11cm
VH350-6550 #5



Osher

Iris Forceps
very fine textured jaws
angled, 11cm
VH350-6558



Jewelers

Forceps
extra delicate, angled, 11cm
VH350-6560 #5/45



Jewelers

Forceps
curved, 11cm
VH350-6570 #7



Suture

Removal Forceps
very fine pointed tips with textured
jaws Ideal for grasping wet sutures, 10cm
VH350-6575



Jaffe

Utility Forceps
very delicate smooth jaws curved, 10cm
VH350-6600



Arruga

Capsule Forceps, 10cm
VH350-7000



Rigid IOL implantation forceps

Rigid IOL implantation forceps, angled, 10cm
VH350-700015



Implantation forceps

Implantation forceps
for 5.5 and 6.0 mm acrylic IOLs, 10cm
VH350-600006



Ernest

Nucleus Cracker
extra delicate cross-action
serrated paddle tips
For cracking the nucleus
through a 2.5mm incision, 12cm
VH350-7240



Ernest

Micro Nucleus Cracker
extra delicate cross-action
serrated paddle tips
For cracking the nucleus
through a 2mm incision, 12cm
VH350-7242



Dodick

Nucleus Cracker
cross-action
longitudinally serrated
paddle shaped jaws
For cracking the nucleus
through a 3mm incision, 12cm
VH350-7244

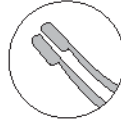

Hu Femto Forceps

Blunted 0.3mm tips
cross-action mechanism
For opening incisions
created with a
femtosecond laser, 12cm
VH350-7245



Alfonso

Nucleus Grasping Forceps
two short rows of
delicate interlocking teeth
For grasping and extracting
nucleus fragments, 12cm
VH350-7253



Coaxial Forceps

Coaxial forceps for endothelial
lenticule insertion in DSEK technique,
atraumatic, 15cm
VH350-3839T titanium



Corneal-scleral punch

Corneal-scleral punch,
straight, Ø 1.5 mm Ø 1.7 mm, 15cm
VH350-2865

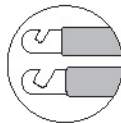

FORCEPS

Stripping Forceps

Stripping forceps for the Schlemm's canal, straight, 12cm
VH350-3278.7

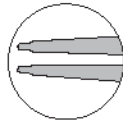

Stripping Forcepdick

Stripping forceps for the Schlemm canal, curved tip, 12cm
VH350-3279

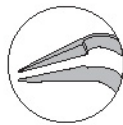

Dodick

IOL folding forceps for soft IOLs, 12cm
VH350-8210

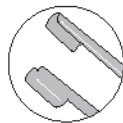

Livernois

IOL folding forceps concave jaw surfaces for soft IOLs, 12cm
VH350-8215



Faulkner

Lens Holding Forceps
round, smooth jaws
For holding soft IOLs, 12cm
VH350-8230



Buratto

Soft IOL Inserting Forceps
extra delicate highly polished
convex jaws for foldable acrylic and
silicone IOLs, 10cm
VH350-8268



Spaleck

Soft IOL Inserting Forceps
delicate highly polished convex jaws
For foldable acrylic and silicone IOLs, 10cm
VH350-8270

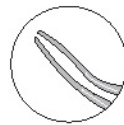

Ernest-McDonald

IOL Inserting Forceps
polished bi-convex jaws
patented cross-action for
acrylic IOLs, 12cm
VH350-8272



JAWS CROSS SECTION



Bechert

Lens Holding Forceps
very delicate flat jaws
gently curved, 12cm
VH350-8476

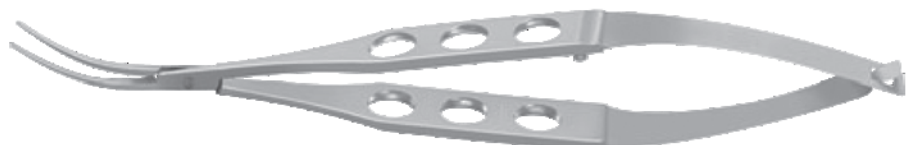

FORCEPS

Blaydes

Lens Holding Forceps
very delicate narrow jaws
angled 45°, 12cm
VH350-8500

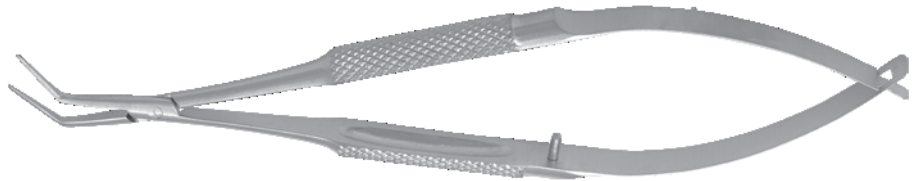

Shepard

Lens Holding Forceps
duckbill shaped jaws
gently curved, 12cm
VH350-8600

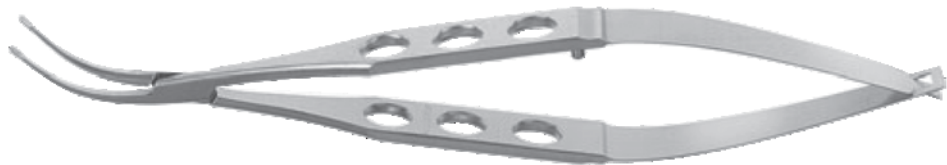

Clayman

Lens Holding Forceps
delicate angled jaws
gently curved, 12cm
VH350-8700



Jameson

Muscle Forceps
with slide lock, 10.5cm
VH350-9000 4 teeth, child size, right
VH350-9010 4 teeth, child size, left
VH350-9020 6 teeth, adult size, right
VH350-9030 6 teeth, adult size, left



Berke

Ptosis Forceps
with slide lock
longitudinally grooved jaws, 10.5cm
VH350-9300 20mm long
VH350-9310 27mm long



Steinert

IOL Inserting Forceps
conically shaped jaws
with flat inside surfaces
Used for folding and
inserting soft IOLs, 10cm
VH350-8219



Livernois

IOL Holding Forceps
highly polished round jaws
For holding a soft IOL
while folding with an
inserting forceps, 10cm
VH350-8220 straight
VH350-8221 angled

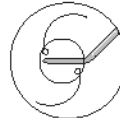

Livernois - McDonald

IOL Inserting Forceps
5mm long concave jaws
patented cross-action
For inserting silicone IOLs, 12cm
VH350-8225



Ernest - McDonald

IOL Inserting Forceps
5mm long straight jaws
low profile
patented cross-action
For inserting silicone IOLs, 12cm
VH350-8228



Ernest - McDonald

Lens Cartridge Loading Forceps
straight, 20 gauge jaws feature a
series of concave and convex surfaces, 12cm
VH350-8229



Chalazion Forceps

round, 9cm

VH350-9450 Lambert, 8mm I.D.

VH350-9500 Hunt, 12mm I.D.

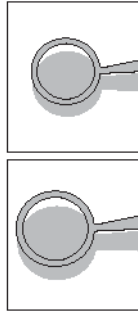

Chalazion Forceps

oval, 9cm

VH350-9550 Baird, 11 x 8mm I.D. small

VH350-9600 Francis, 14 x 11mm I.D. medium

VH350-9650 Desmarres, 20 x 13mm I.D. large

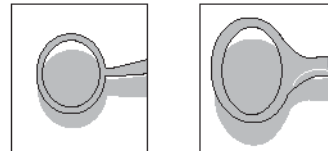

Desmarres Forceps

Oval, 9cm

VH350-2125 25mm



Watzke

Forceps

Sleeve Spreading Forceps, 12cm

VH350-7950



Hartmann

Mosquito Forceps
extra delicate

3 ³/₄" (95mm) long, 9cm

VH350-9900 straight

VH350-9900T titanium straight

VH350-9910 curved

VH350-9910T titanium curved



Halsted

Mosquito Forceps
delicate

5" (125mm) long, 12.5cm

VH350-9940 straight

VH350-9940T titanium straight

VH350-9950 curved

VH350-9950T titanium curved

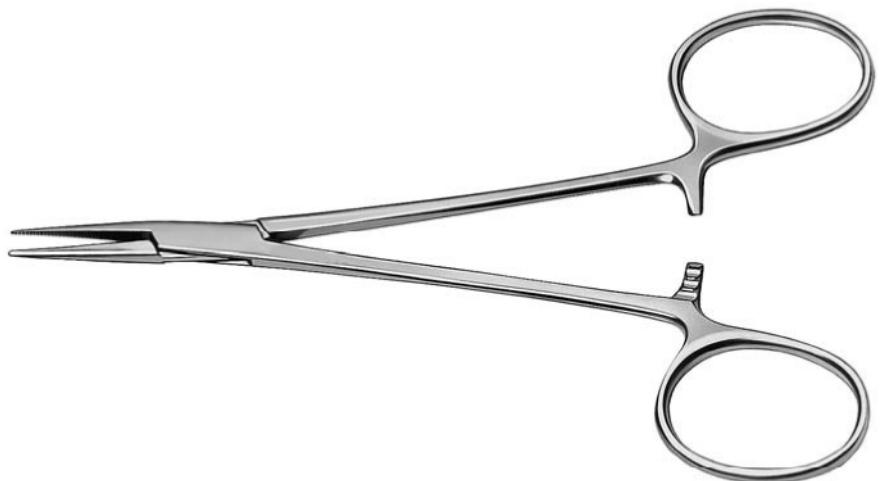

Halsted

Mosquito Forceps
delicate 1x2

5" (125mm) long, 12.5cm

VH350-9970 straight

VH350-9970T titanium straight

VH350-9980 curved

VH350-9980T titanium curved



Backhaus

Towel Clamp

VH350-9964 3½" (90mm), 9cm

VH350-9965 5¼" (135mm), 12.5cm

VH350-9964T 3½" (90mm), 9cm titanium

VH350-9965T 5¼" (135mm), 12.5cm titanium



Halsted

Towel Clamp

Cross Action

VH350-9960 (55mm) long, 5.5cm



Schaedel

Towel Clamp

Cross Action

VH350-9961 (90mm) long, 9cm



Serrefine

serrated jaws

VH350-9850 small (38mm), 3.8cm



Dieffenbach Serrefine

VH350-9851 Straight, 50 mm, 5cm

VH350-9852 curved, 50 mm, 5cm



Pean Forceps

Mosquito forceps,
straight, serrated jaws, 14cm

VH350-2720



Ramplays Forceps

Ramplay sponge forceps

VH350-9920 18cm

VH350-9921 25cm

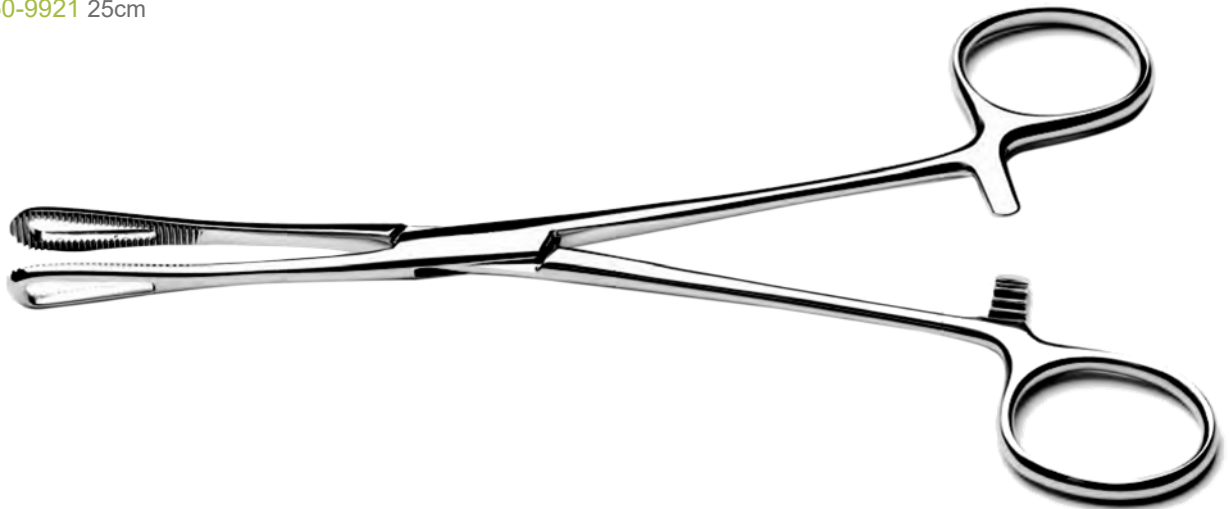

Frazier

Suction and wash tube,
with hole on/off, 12cm long, 11.5cm

VH320-1861

Suction and wash tube,
with hole on/off, 17cm long, 11.5cm

VH320-1862



VeHu

SALES & PRODUCTION

VH360

- Needle Holders

VeHu
SALES & PRODUCTION

McPherson

Needle Holder

very delicate jaws, 11.5cm

VH360-1000 with lock straight

VH360-1010 without lock straight

VH360-1020 with lock curved

VH360-1030 without lock curved



Jaffe

Needle Holder

delicate conical jaws, 13cm

VH360-1100 with lock straight

VH360-1120 with lock curved

VH360-1130 without lock curved



Castroviejo

Needle Holder

delicate jaws straight, 14cm

VH360-1500 with lock

VH360-1510 without lock



Castroviejo

VH360-1600 with lock, 14cm

VH360-1610 without lock, 14cm



Silcock Needle Holder, catch

VH360-1611 16cm



NEEDLE HOLDER

Castroviejo

Needle Holder
delicate jaws curved, 14cm
VH360-1520 with lock
VH360-1530 without lock



Castroviejo

Needle Holder
standard jaws
straight, with lock, 14cm
VH360-1560
VH360-1560TC Tungsten Tip TC



Castroviejo

Needle Holder
standard jaws curved, 14cm
VH360-1580 with lock
VH360-1580T titanium with lock
VH360-1581 without lock
VH360-1581T titanium without lock



Kalt

Needle Holder
delicate smooth jaws
straight, with lock, 15cm
VH360-1800



Drews

Needle Holder
extra delicate jaws, 10cm
VH360-2990 straight, with lock
VH360-2991 straight, without lock
VH360-2992 curved, with lock
VH360-2993 curved, without lock



Castroviejo

Needle Holder

delicate jaws titanium, 14cm

VH360-1500T with lock str titanium

VH360-1520T with lock cvd titanium

VH360-1530T without lock cvd titanium

VH360-1560T with lock standard titanium



Barraquer

Needle Holder

short model

very delicate jaws

curved, 10cm

VH360-3020 with lock

VH360-3030 without lock



Troutman

Needle Holder

delicate jaws

strongly curved, 13cm

VH360-3250 without lock

VH360-3260 with lock



Barraquer

Needle Holder

very delicate jaws

curved, 13cm

VH360-3300 with lock

VH360-3310 without lock

VH360-3300T with lock titanium

VH360-3310T without lock titanium



Barraquer

Needle Holder

delicate jaws

straight, 13cm

VH360-3500 with lock

VH360-3510 without lock



NEEDLE HOLDER

Barraquer

Needle Holder
delicate jaws
curved, 13cm
VH360-3520 with lock
VH360-3530 without lock



Needle Holder
delicate jaws
curved large, 13cm
VH360-3540 with lock
VH360-3550 without lock

Barraquer

Needle Holder
standard jaws
curved, 13cm
VH360-3620 with lock
VH360-3620TC Tungsten Carbide with lock
VH360-3620T titanium with lock

VH360-3630 without lock
VH360-3630TC Tungsten Carbide without lock
VH360-3630T titanium without lock



Anis

Needle Holderextra delicate jaws, 14cm
VH360-3750 with lock straight
VH360-3751 without lock straight
VH360-3752 with lock curved
VH360-3753 without lock curved



Micro Needle Holder

Needle Holderextra delicate jawsstraight, 14cm
VH360-3800 with lock
VH360-3800T titanium with lock
VH360-3810 without lock
VH360-3810T titanium without lock



Barraquer (Golf Pattern)

Needle Holder
short model
very delicate jaws
Curved, 12cm
VH360-1620 with lock
VH360-1630 without lock



Barraquer

Needle Holder
short model
very delicate jaws
curved, 12.5cm
VH360-1640 with lock
VH360-1650 without lock



Micro Needle Holder

Needle Holder
delicate jaws straight, 14cm
VH360-1660 without lock
VH360-1670 with lock



Needle Holder

delicate,
curved, without lock,
overall length: 115 mm, titanium
Ideal for 9-0 to 10-0 sutures, 12cm
VH360-1680 with lock
VH360-1690 without lock
VH360-1680T with lock titanium
VH360-1690T without lock titanium



Barraquer

Needle Holder
delicate jaws
straight, 12cm
VH360-1700 with lock
VH360-1710 without lock
VH360-1700T with lock, titanium
VH360-1710T without lock, titanium



SALES & PRODUCTION

VH370

- Lacrimal Instruments
- Bimanual I/A
- Quickswitch I/A System
- Infusion Handles
- Roungeurs
- Nasal Speculums
- Elevators
- Chisels
- Mallets
- Probes

Kerrison

Bone Nibbling Rongeur

9mm opening, 16cm

VH370-1800 size 0, 3.0mm wide

VH370-1801 size 1, 3.5mm wide

VH370-1802 size 2, 4.0mm wide

VH370-1803 size 3, 4.5mm wide



Citelli

Bone Nibbling Rongeur

7mm opening

2.0mm wide, 16cm

VH370-1805

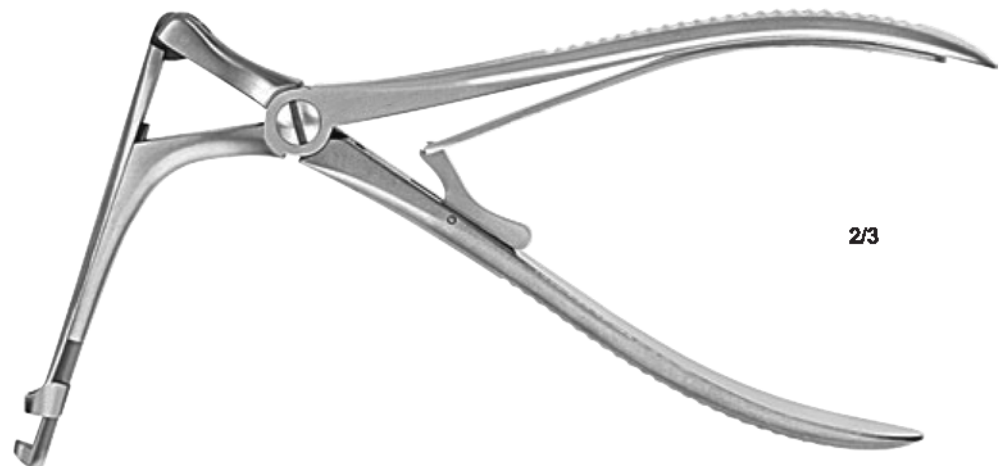

Beyer

Rongeur

single action, 16cm

VH370-1810



Kerrison

Spaculum, 15cm
 VH370-1820 infant
 VH370-1821 child
 VH370-1822 adult



2/3

Freer

Periosteal Elevator
 one end blunt
 other end semi-sharp
 4.5mm wide blades, 16.5cm
 VH370-1830



2/3

Joseph

Periosteal Elevator
 gently curved tip, 15cm
 VH370-1835



3/4

West

Lacrimal Chisel
 straight, 15cm
 VH370-1840



3/4

Freer

Lacrimal Chisel
 curved, 15cm
 VH370-1845



Castroviejo

lead filled
stainless steel head, 16cm
VH370-1860



2/3

Harms

Trabeculotomy Probe, 4.5c
VH370-1000 right
VH370-1010 left



Infant

Lacrimal Dilator
very fine blunt tip, 10cm
VH370-2000



Muldoon

Lacrimal Dilator, 10cm
VH370-2100



Wilder

Lacrimal Dilator, 11cm
VH370-2110 size 1, fine taper
VH370-2120 size 2, medium taper
VH370-2130 size 3, heavy taper

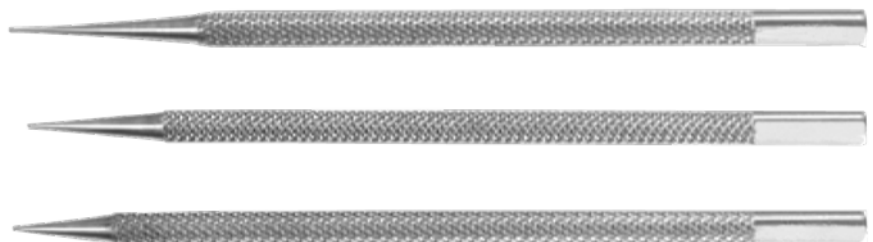

Castroviejo

Lacrimal Dilator
double-end
fine and
medium taper, 11cm
VH370-2300



Bowman

Lacrimal Probe
malleable stainless steel, 13cm
VH370-2500 set of 6
VH370-2510 size 0000 & 000
VH370-2520 size 00 & 0
VH370-2530 size 1 & 2
VH370-2540 size 3 & 4
VH370-2550 size 5 & 6
VH370-2560 size 7 & 8

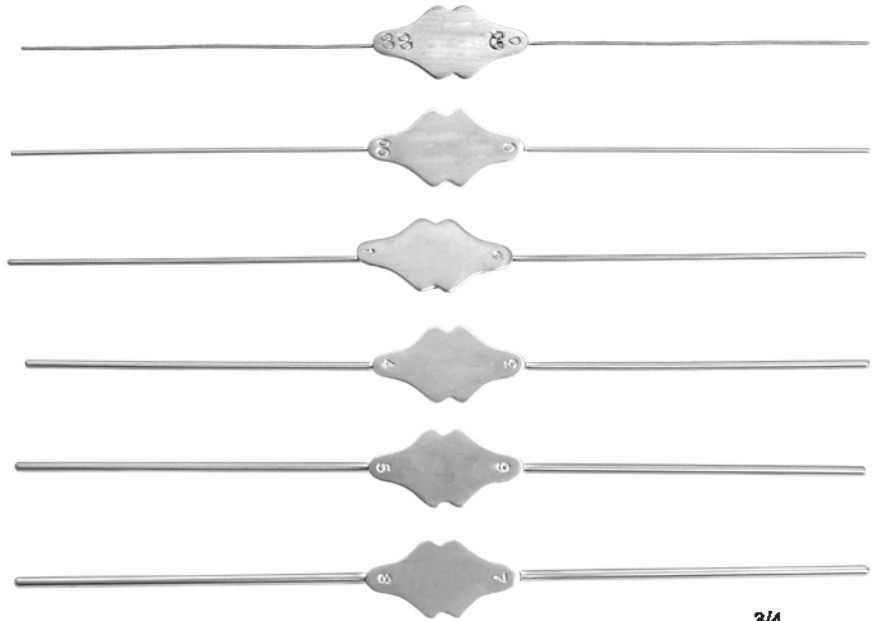

3/4

Catalano

Lacrimal Intubation Set includes 2 blunt
0.7mm diameter probes
attached to 30.5cm long
silicone tubing
.012" I.D., .025" O.D.
VH370-2610 set, 57cm
VH370-2602 silicone tubing only, 30.5cm



3/4

Crawford

Lacrimal Intubation Set
includes 2 olive tip
0.6mm diameter probes
attached to 30.5cm long
silicone tubing
.012" I.D., .025" O.D.
VH370-2620 set, 30.5cm
VH370-2602 silicone tubing only, 30.5cm
VH370-2603 silicone tubing only, 30.5cm



3/4

Crawford

Retrieving Hook
for Crawford lacrimal
intubation probes, 57cm
VH370-2623



Pigtail

Probe
with suture holes, 14cm
VH370-2900



Rollet Ruginé

14cm
VH370-2910



Nettleship Lacrimal Dilator

Nettleship lacrimal dilator 14cm

single end
VH370-2920

Nettleship lacrimal dilator
double end 13cm
VH370-2930

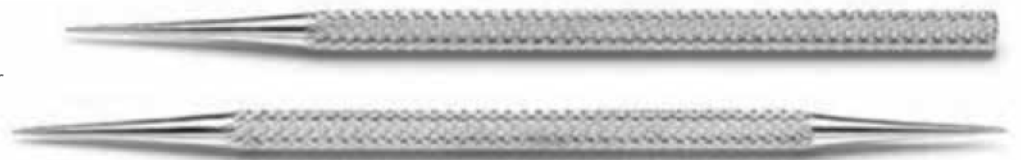

Howarth Periosteal Elevator

Howarth Periosteal Elevator,
for DCR, 215mm length, 14cm
VH370-2940



Fison Retractor

Fison Retractor, for detachment, 14cm
VH370-2950



CANNULAS

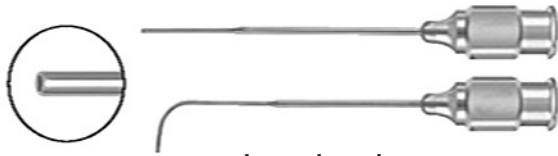

Lacrimal

Cannula malleable tip
23 gauge
VH370-3000 straight, 2.5cm Shaft
VH370-3010 curved, 2.5cm Shaft

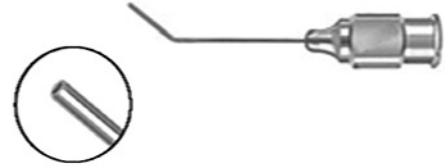

Air Injection

Cannula angled at 7mm
VH370-3502 30 gauge, 1.9cm Shaft
VH370-3522 27 gauge 1.9cm Shaft



Dalk

Air Injection Cannula flattened, 27 gauge vaulted 0.2mm posterior port near tip
VH370-3590 27 gauge, 1.9cm Shaft

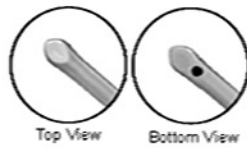

Dalk

DALK Cannula flattened "cobra-shaped" tip 0.2mm posterior port
VH370-3595 27 gauge, 1.9cm Shaft



Lasek

Alcohol Cannula delicate olive shaped tip angled at 10mm 25 gauge 2.5cm Shaft
VH370-3805

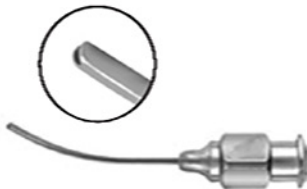

Stevens

Sub-Tenon's Anesthesia Cannula gently curved, flat tip 19 gauge 1.9cm Shaft
VH370-4005

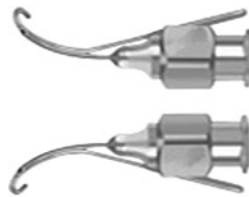

Gess

Irrigating-Aspirating Cannula U-shaped, with end opening aspiration port, 23 gauge Supplied with silicone tubing and adaptor, 300 mm silicone tubing. 16 mm.
VH370-4304 curved right
VH370-4305 curved left

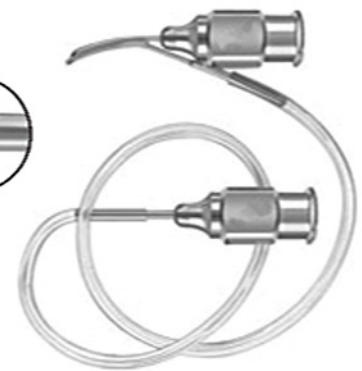
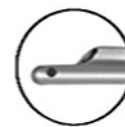

Simcoe

Irrigating-Aspirating Cannula original model, 15mm long, 0.3mm diameter aspiration port, 300 mm silicone tubing. 16 mm.
VH370-4300

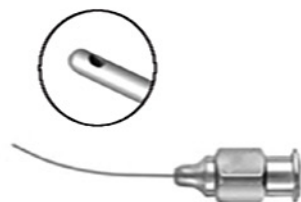

Corbin

Sub-Tenon's Anesthesia Cannula smooth rounded tip 0.3mm side port 23 gauge 1.9cm Shaft
VH370-4008

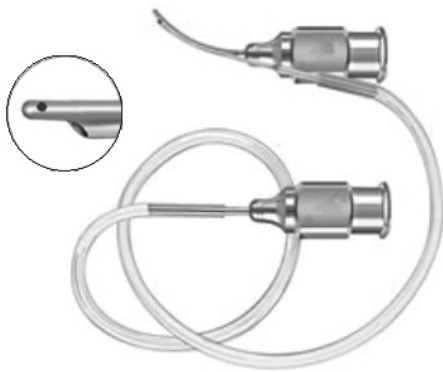

Reversed Simcoe

Irrigating-Aspirating Cannula
15mm long 0.3mm diameter
aspiration port front
opening irrigation port 23 gauge
300 mm silicone tubing. 16 mm
VH370-4302

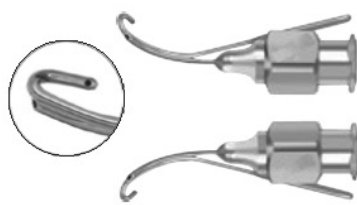

Simcoe

Irrigating-Aspirating Cannula
U-shaped, with 0.3mm anterior
aspiration port, 23 gauge, 1.3cm Shaft
VH370-4308 curved right
VH370-4309 curved left

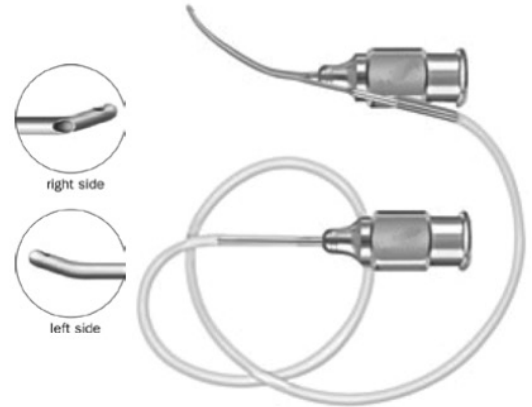

Strauss-Simcoe

MSICS I/A Cannula
23 gauge, 0.3mm port
elongated and gently curved
with 15° angled tip, 1.3cm Shaft
VH370-4320

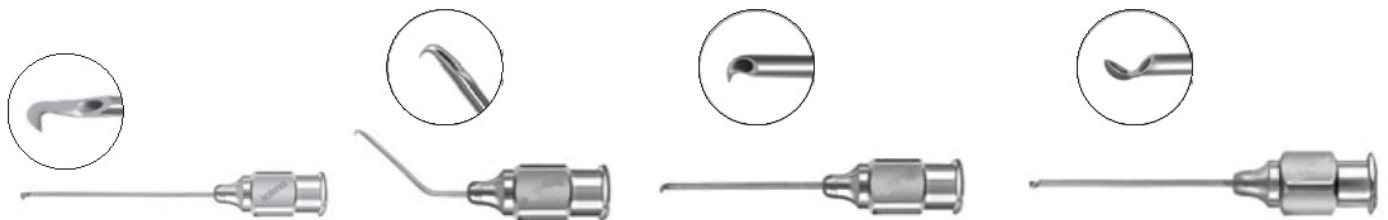

Kelman

Cystotome
sharp point and
sharp cutting edge
22 gauge, 2.7cm Shaft
VH370-4600

McIntyre

Cystotome
angled at 10mm
sharp point
23 gauge, 2.7cm Shaft
VH370-4680

Lieppman

Cystotome
extra small sharp point
and sharp cutting edge
22 gauge, 2.7cm Shaft
VH370-4700

Shamas

Posterior Capsule
Polishing Curette
1mm diameter cup
with textured base
22 gauge, 2.7cm Shaft
VH370-4850

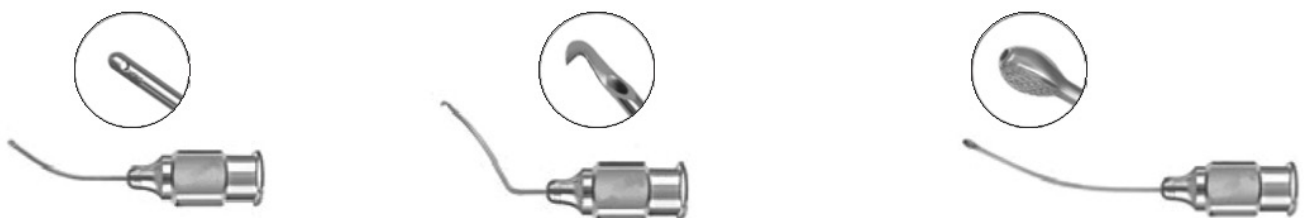

Shapiro

Posterior Capsule
Polisher carbide
impregnated tip dual
0.3mm side ports
curved, 23 gauge, 2.7cm Shaft
VH370-4906

Kratz

Cystotome
sharp point and
sharp cutting edge
formed, 22 gauge, 2.7cm Shaft
VH370-4601

Jensen

Posterior Capsule
Polisher carbide
impregnated on posterior
surface of olive tip
front opening, 2.7cm Shaft
VH370-4920 25 gauge
VH370-4930 23 gauge

Bishop-Harmon

Anterior Chamber Irrigator includes 19 gauge angled cannula, adaptor and blue silicone bulb

VH370-5000 complete, 2.5cm Shaft

VH370-5005 silicone bulb, 1.7cm Shaft and adaptor

VH370-5010 silicone bulb, 1.7cm Shaft

VH370-5020 adaptor, 1.7cm Shaft

VH370-5050 19 gauge cannula, 1.7cm Shaft

VH370-5052 21 gauge cannula, 1.7cm Shaft



Lu

Posterior Capsule Polisher flattened olive shaped tip carbide impregnated on the posterior surface front opening, 23 gauge, 2.7cm Shaft
VH370-4933



Dahan

Nucleus Prolapsing Cannula angled at 4mm miniature olive tip with 0.15mm end opening 25 gauge, 1.7cm Shaft
VH370-5058



Hydrodissection

Cannula angled at 8mm flat tip, front opening 25 gauge, 1.7cm Shaft
VH370-5054



Irrigating Cannula

dual 0.4mm side ports 23 gauge thin wall, 1.7cm Shaft
VH370-5095



Fukasaku

LASIK Cannula low profile tip, end opening 23 gauge, 1.7cm Shaft
VH370-5108

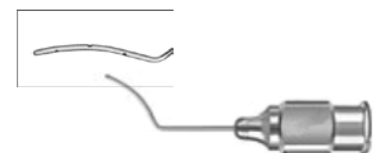

Banaji

LASIK Cannula bullet shaped tip 6 ports for multi-directional irrigation 25 gauge, 1.7cm Shaft
VH370-5112 smooth
VH370-5113 textured



Buratto

LASIK Cannula slightly flattened one front and two side ports, 1.7cm Shaft
VH370-5117 25 gauge
VH370-5118 23 gauge



McIntyre

Anterior Chamber Cannula smooth blunt tip, front opening
VH370-5120 23 gauge, straight, 1.7cm Shaft
VH370-5130 23 gauge, angled, 1.7cm Shaft
VH370-5140 26 gauge, straight, 1.7cm Shaft
VH370-5150 26 gauge, angled, 1.7cm Shaft
VH370-5160 30 gauge, straight, 1.7cm
VH370-5170 30 gauge, angled, 1.7cm

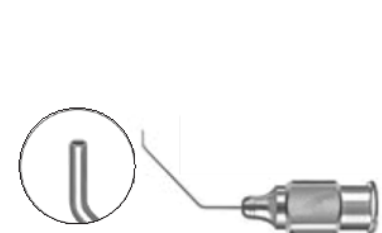

Gimbel

Cortex Aspirating Cannula end opening 30 gauge, 1.7cm
VH370-5174



Vidaurri

LASIK Cannula
double-armed
8 irrigating ports
25 gauge, 1.7cm Shaft
VH370-5180 vertical
VH370-5181 horizontal



Simcoe

Cortex Extractor
0.3mm side port
13mm long, 23 gauge, 1.3cm Shaft
VH370-5220 smooth tip
VH370-5221 textured tip

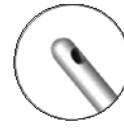

Simcoe

Cortex Extractor
0.3mm side port
21mm long, 23 gauge, 1.3cm Shaft
VH370-5230 smooth tip
VH370-5231 textured tip



McIntyre-Binkhorst

Cannula, "J" shape
smooth blunt tip
end opening, 26 gauge, 1.7cm Shaft
VH370-5440 angled right
VH370-5445 straight
VH370-5450 angled left



Chang

Hydrodissection Cannula
flat tip angled 90°
with beveled opening
27 gauge
VH370-5464 standard tip, 1.3cm Shaft
VH370-5466 long tip, 1.7cm Shaft



Knolle-Pearce

Irrigating Vectis
fluid flow through
three front opening
ports 23 gauge loop
6 x 9 mm Loop. 38 mm
VH370-5500



Simcoe

Irrigating Lens Nucleus Loop
two front opening ports
finely serrated, strong curve
25 gauge, 1.3cm Shaft
VH370-5530 right
VH370-5531 left

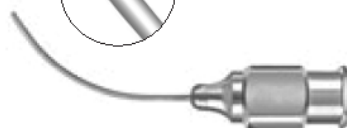

Simcoe

Cortex Extractor
0.4mm side port
21mm long
23 gauge thin wall
1.3cm Shaft
VH370-5232



Alfonso-McIntyre

Irrigating Nucleus Spoon
single 0.3mm
front opening port
1.3cm Shaft
VH370-5532 2.5mm wide
VH370-5533 4.0mm wide

I/A BIMANUAL HANDLES

Infusion Handle

Infusion Handle, 12cm

VH370-6805 male/male connectors

VH370-6806 male/female connectors



Aspiration Handpieces

with male connector

side port facing into curve

magenta color titanium, 11cm

VH370-5804 23 gauge, 0.3mm port

VH370-5805T 23 gauge, 0.3mm port, textured tip titanium

VH370-5810T 21 gauge, 0.35mm port titanium

VH370-5811T 21 gauge, 0.35mm port, textured tip titanium

VH370-5814T 21 gauge, 0.4mm port titanium

VH370-5815T 21 gauge, 0.4mm port, textured tip titanium

VH370-5816T 22 gauge, 0.3mm port, ova titanium

VH370-5817T 22 gauge, 0.3mm port, oval, textured tip titanium

VH370-5822T 20 gauge, 0.3mm port, oval titanium

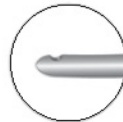

Aspiration



Irrigation



Irrigation Handpieces

with female connector, blue color, 11cm

VH370-5836T 23 gauge, dual 0.3mm side ports titanium

VH370-5838T 22 gauge, dual 0.4mm side ports, oval titanium

VH370-5840T 21 gauge, dual 0.5mm side ports titanium

Aspiration Handpieces Ø21G

Curved sandblasted tip

titanium handle, 11cm

VH370-2233-1T titanium



GOLD = aspirating →

Irrigation Handpieces Ø21G

Curved tip, dual sideports,

titanium handle, 11cm

VH370-2232-2T titanium



BLUE = irrigating ←



Scoring Hook and Aspirating Handpiece

Scoring hook and aspirating handpiece

for DSEK procedure, 11cm

VH370-2183.14T titanium



Plastic Sterilizing Cases

Autoclavable plastic
with silicone finger mat
base, lid and mat are perforated
for steam penetration
Catalog # Size # of Instr Sizes (mm)
VH390-2020 small 2-3 160x70x25



Plastic Trays

Autoclavable plastic
with silicone finger mat
base, lid and mat are perforated
for steam penetration
Catalog # Size # of Instr Sizes (mm)
VH390-2030 large 10-15 265x160x25
VH390-2040 large, double level 20-25 265x160x50

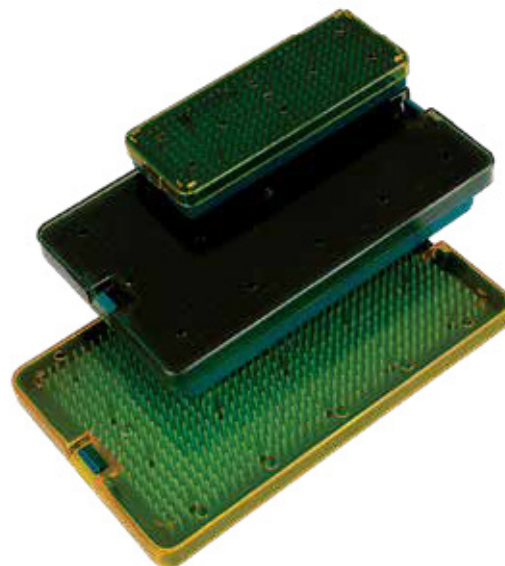

Sterilization Perforated Case with Lid

S.S Sterilizing Case inox with silicone
finger mat base, lid and mat are perforated
for steam penetration

VH390-22518356

252 x 209 x 24mm silicon matt

VH390-22518357

189 x 209 x 24mm silicon matt

VH390-22518358

126 x 209 x 24mm silicon matt



Sterilization Tray with Lid

S.S Perforated stainless steel tray
with lid with silicon fitting
Size: 240x250x38mm
VH390-22000



Fine Mesh Trays for Micro Instruments with Silicon Mat

These trays are especially designed for sterilizing delicate micro instruments.

The mesh size of these trays are 1.6mm, which helps to clean the instruments from all directions.

- VH390-4350 160 X 70 X 20mm
- VH390-4351 160 X 100 X 20mm
- VH390-4352 200 X 125 X 20mm
- VH390-4353 200 X 150 X 20mm
- VH390-4354 265 X 160 X 20mm
- VH390-4355 210 X 190 X 20mm
- VH390-4356 250 X 250 X 20mm for Cataract Set



Fine Mesh Cassettes with Silicon Fittings for Micro Instruments

- VH390-4248 200 X 70 X 40 for 3 Micro Retinal Instruments
- VH390-4249 200 X 90 X 40 for 5 Micro Instruments
- VH390-4250 200 X 150 X 40 for 10 Micro Instruments
- VH390-4251 200 X 210 X 40 for 15 Micro Instruments



Micro Instruments Tray

Tray with silicone finger mat
base, lid and mat are perforated
for steam penetration

VH390-4243 for 5 instr 185x60x23mm

VH390-4244 for 10 instr 185x30x23mm

VH390-4245 for 15 instr 185x205x45mm



Ophthalmic tray

S.S Ophthalmic tray with silicon mat

VH390-35000 for 5 instruments

VH390-35000-1 for 10 instruments

VH390-35000-2 for 15 to 20 instruments



Full Perforated Tray

Tray Specially designed for small parts and burrs

VH390-4944 40 X 40 X 30mm

VH390-4945 80 X 80 X 50mm

VH390-4946 90 X 90 X 50mm



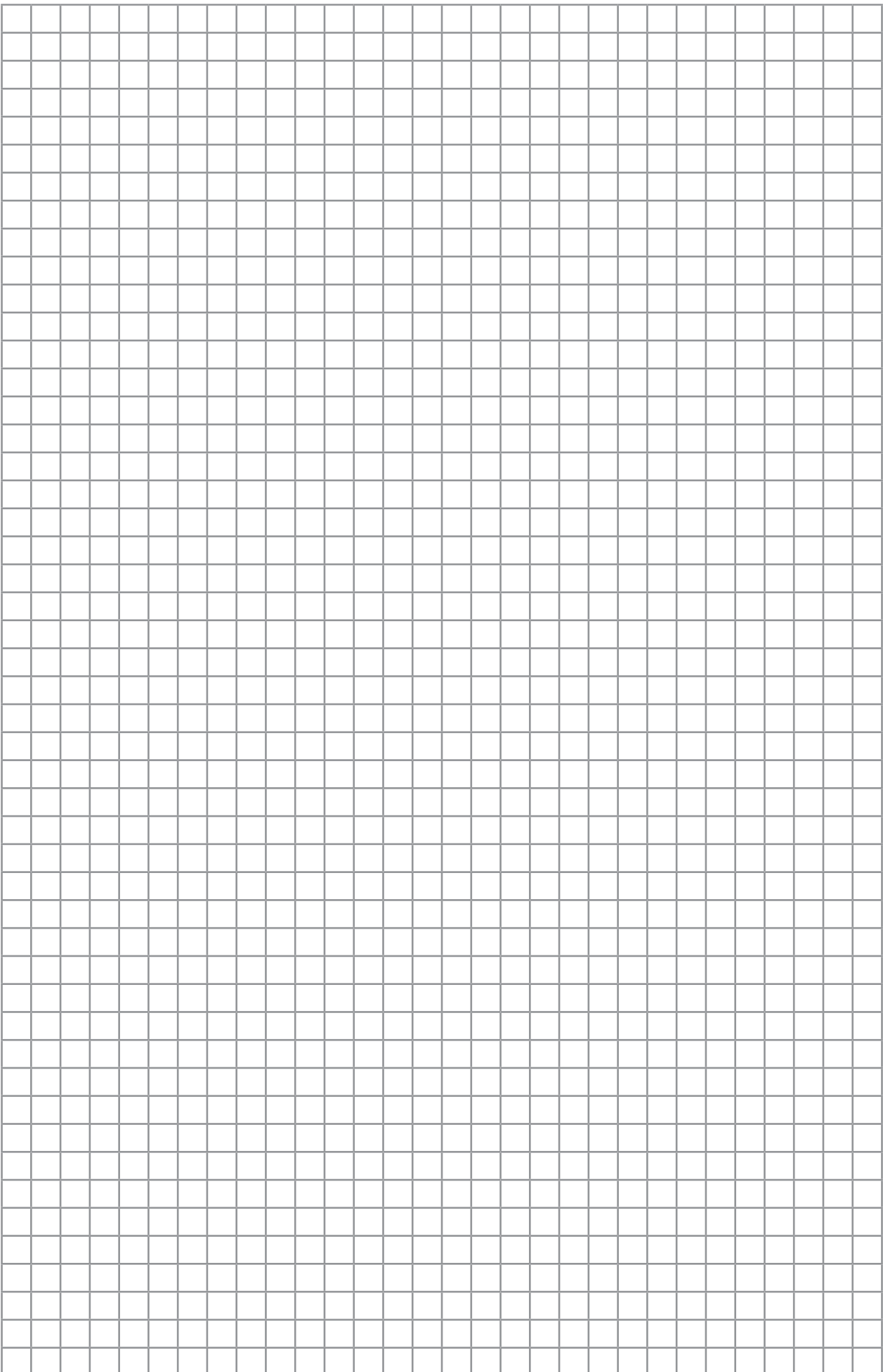



Wir behalten uns vor, Änderungen und Verbesserungen durchzuführen und die Instrumente und Geräte ohne besonderen Hinweis in der modifizierten Ausführung auszuliefern.

Die Verwendung dieses Kataloges zu anderen Zwecken als ausschließlich der zum Vertrieb von VeHu Produkten ist untersagt. Zuwiderhandlungen werden rechtlich geahndet. Der Nachdruck, auch auszugsweise, ist verboten.



We reserve the right of technical modifications and improvements and to supply the instruments and apparatus without specific indication in the modified finish.

The use of this catalogue is restricted to actions necessary for selling original VeHu products. The use for any purpose other than selling original VeHu products is prohibited and will be prosecuted. Reprinting, even partially, is not allowed



VeHu-Medical GmbH

Dr. Karl Storz Str. 25
D-78532 Tuttlingen

Tel. +49(7461) 163311
Fax.+49(7461) 163312
info@vehu.de
www.vehu.de

